

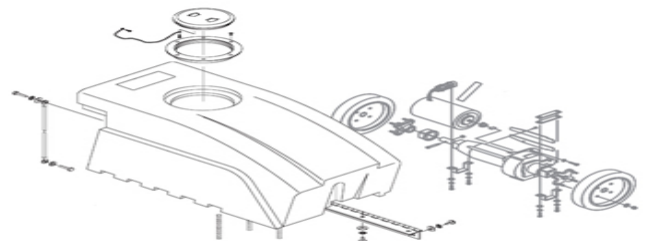

6650

(Diesel)

Sweeper Operator Manual

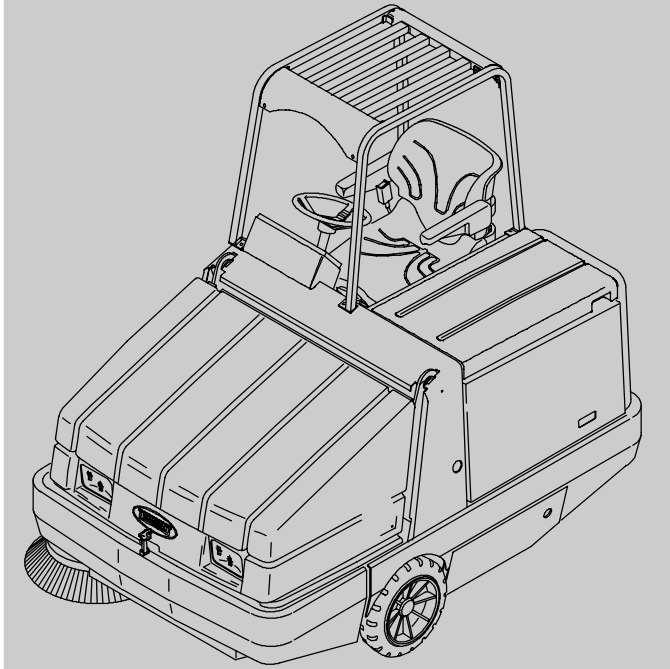

FLOOREQUIPMENTPARTS.COM

North America / International

www.tennantco.com

330930
Rev. 05 (03-2008)





This manual is furnished with each new model. It provides necessary operation and maintenance instructions.

Read this manual completely and understand the machine before operating or servicing it.

This machine will provide excellent service. However, the best results will be obtained at minimum costs if:

- The machine is operated with reasonable care.
- The machine is maintained regularly - per the machine maintenance instructions provided.
- The machine is maintained with manufacturer supplied or equivalent parts.

	PROTECT THE ENVIRONMENT Please dispose of packaging materials, old machine components including batteries, hazardous fluids such as antifreeze and oil, in an environmentally safe way according to local waste disposal regulations. Always remember to recycle.
	

MACHINE DATA	
Please fill out at time of installation for future reference.	
Model No. -	_____
Serial No. -	_____
Machine Options -	_____
Sales Rep. -	_____
Sales Rep. phone no. -	_____
Customer Number -	_____
Installation Date -	_____

Tennant Company
PO Box 1452
Minneapolis, MN 55440
Phone: (800) 553-8033 or (763) 513-2850
www.tennantco.com



CALIFORNIA PROPOSITION 65 WARNING:

Engine exhaust from this product contains chemicals known to the State of California to cause cancer, birth defects, or other reproductive harm.

Thermo-Sentry, II-Speed, Perma-Filter, 1 Step, Duramer, Vario Sweeping Brush, and VCS are US registered trademarks of Tennant Company.

Specifications and parts are subject to change without notice.

Original instructions, Copyright © 2003-2008 TENNANT Company, Printed in U.S.A.

CONTENTS

	Page		Page
SAFETY PRECAUTIONS	3	HOW THE MACHINE WORKS	33
OPERATION	7	PRE-OPERATION CHECKLIST	33
OPERATOR RESPONSIBILITY	7	STARTING THE MACHINE	34
MACHINE COMPONENTS	8	SWEEPING AND BRUSH INFORMATION	36
CONTROL PANEL SYMBOLS	9	SWEEPING	37
CONTROLS AND INSTRUMENTS	11	STOP SWEEPING	38
OPERATION OF CONTROLS	12	EMPTYING THE HOPPER	39
DIRECTIONAL PEDAL	12	STOP THE MACHINE	41
BRAKE PEDAL	13	POST-OPERATION CHECKLIST	42
PARKING BRAKE LEVER	13	ENGAGING HOPPER SUPPORT BAR ..	43
ONE STEP SWITCH	14	DISENGAGING HOPPER SUPPORT BAR	45
SHAKE FILTER SWITCH	15	OPERATION ON INCLINES	46
SIDE BRUSH SWITCH	15	OPTIONS	47
VACUUM FAN SWITCH	15	VACUUM WAND	47
ENGINE SPEED CONTROL SWITCH	16	BLOWER WAND	51
LCD DISPLAY	16	HEATER VALVE	52
HOURMETER	16	MACHINE TROUBLESHOOTING	53
FUEL GAUGE	17	MAINTENANCE	54
HOPPER OPEN SWITCH	17	MAINTENANCE CHART	54
HOPPER CLOSE SWITCH	17	LUBRICATION	56
HOPPER UP SWITCH	18	ENGINE	56
HOPPER DOWN SWITCH	18	REAR WHEEL SUPPORT	56
HORN BUTTON	18	HOPPER BEARINGS	57
MAIN BRUSH ADJUSTMENT KNOB ..	19	FRONT WHEEL BEARINGS	57
TURN SIGNAL SWITCH (OPTION) ...	20	HYDRAULICS	58
LOW ENGINE OIL PRESSURE LIGHT	21	HYDRAULIC FLUID RESERVOIR	58
HIGH ENGINE TEMPERATURE LIGHT	21	HYDRAULIC FLUID	58
MAIN BROOM STALLED LIGHT	21	HYDRAULIC HOSES	59
CLOGGED DUST FILTER LIGHT	22	PROPELLING MOTOR	59
THERMO SENTRY LIGHT	22	ENGINE	60
LOW FUEL LIGHT	22	COOLING SYSTEM	60
ALTERNATOR LIGHT	23	AIR FILTER INDICATOR	61
GLOW PLUG LIGHT	23	AIR FILTER	61
STEERING WHEEL	23	TO REPLACE AIR FILTER	61
STEERING COLUMN TILT LEVER ...	23	FUEL FILTER	63
IGNITION SWITCH	24	FUEL PIPES	63
OPERATING/HAZARD LIGHTS		PRIMING FUEL SYSTEM	63
SWITCH	25	BATTERY	64
SIDE BRUSH DOWN PRESSURE		BELTS AND CHAINS	64
KNOB	25	ENGINE FAN BELT	64
FUSES	26	STATIC DRAG CHAIN	64
CIRCUIT BREAKERS (OPTION)	27	DEBRIS HOPPER	65
LATCHES	28	HOPPER DUST FILTER	65
HOPPER SUPPORT BAR	29	TO REPLACE HOPPER	
DELUXE SUSPENSION SEAT	29	DUST FILTER	66
HEATER KNOB (OPTION)	31	THERMO SENTRY	68
AIR CONDITIONING SWITCH			
(OPTION)	31		
WINDSHIELD WIPER SWITCH			
(OPTION)	31		
DOME LIGHT SWITCH (OPTION)	32		
PRESSURIZER SWITCH (OPTION) ..	32		

CONTENTS

	Page
BRUSHES	69
MAIN BRUSH	69
TO REPLACE MAIN BRUSH	70
TO CHECK AND ADJUST MAIN BRUSH PATTERN	71
SIDE BRUSH	73
TO REPLACE SIDE BRUSH	74
SIDE BRUSH GUARD	74
SKIRTS AND SEALS	75
HOPPER LIP SKIRTS	75
HOPPER SIDE SKIRT	75
BRUSH DOOR SKIRTS	75
REAR SKIRTS	76
SIDE BRUSH DUST CONTROL SKIRTS (OPTION)	76
BRUSH DOOR SEALS	76
HOPPER SEALS	77
HOPPER DOOR SEALS	77
HOPPER FILTER SEALS	78
HOPPER INSPECTION DOOR SEAL .	78
VACUUM WAND DOOR SEALS (OPTION)	78
BRAKES AND TIRES	79
SERVICE BRAKES	79
PARKING BRAKE	79
TIRES	79
REAR WHEEL	79
PUSHING, TOWING, AND TRANSPORTING THE MACHINE	80
PUSHING OR TOWING THE MACHINE	80
TRANSPORTING THE MACHINE	80
MACHINE JACKING	83
STORING MACHINE	83
SPECIFICATIONS	84
GENERAL MACHINE DIMENSIONS/CAPACITIES	84
GENERAL MACHINE PERFORMANCE ..	84
TIRES	84
POWER TYPE	85
STEERING	85
HYDRAULIC SYSTEM	85
BRAKING SYSTEM	85
MACHINE DIMENSIONS	86

SAFETY PRECAUTIONS

The following precautions are used throughout this manual as indicated in their description:



WARNING: To warn of hazards or unsafe practices which could result in severe personal injury or death.

FOR SAFETY: To identify actions which must be followed for safe operation of equipment.

The machine is suited to sweep disposable debris. Do not use the machine other than described in this Operator Manual. The machine is not designed for use on public roads.

The following information signals potentially dangerous conditions to the operator or equipment:



WARNING: Engine emits toxic gases. Severe respiratory damage or asphyxiation can result. Provide adequate ventilation. Consult with your regulatory authorities for exposure limits. Keep engine properly tuned.



WARNING: Raised hopper may fall. Engage hopper support bar.



WARNING: Lift arm pinch point. Stay clear of hopper lift arms.



WARNING: Moving belt and fan. Keep away.



WARNING: Accident may occur. Do not operate vacuum or blower wand while driving.

FOR SAFETY:

1. **Do not operate machine:**
 - Unless trained and authorized.
 - Unless operator manual is read and understood.
 - If it is not in proper operating condition.
 - In flammable or explosive areas unless designed for use in those areas.
 - In areas with possible falling objects unless equipped with overhead guard.
2. **Before starting machine:**
 - Check for fuel, oil, and liquid leaks.
 - Keep sparks and open flame away from refueling area.
 - Make sure all safety devices are in place and operate properly.
 - Check brakes and steering for proper operation.
3. **When starting machine:**
 - Keep foot on brake and directional pedal in neutral.
4. **When using machine:**
 - Do not pick up burning or smoking debris, such as cigarettes, matches, or hot ashes.
 - Use brakes to stop machine.
 - Go slow on inclines and slippery surfaces.
 - Use care when reversing machine.
 - Move machine with care when hopper is raised.
 - Make sure adequate clearance is available before raising hopper.
 - Do not carry passengers on machine.
 - Always follow safety and traffic rules.
 - Report machine damage or faulty operation immediately.
5. **Before leaving or servicing machine:**
 - Stop on level surface.
 - Set parking brake.
 - Turn off machine and remove key.

SAFETY PRECAUTIONS

- 6. When servicing machine:**
 - **Avoid moving parts. Do not wear loose jackets, shirts, or sleeves.**
 - **Block machine tires before jacking machine up.**
 - **Jack machine up at designated locations only. Block machine up with jack stands.**
 - **Use hoist or jack that will support the weight of the machine.**
 - **Wear eye and ear protection when using pressurized air or water.**
 - **Disconnect battery connections before working on machine.**
 - **Avoid contact with battery acid.**
 - **Avoid contact with hot engine coolant.**
 - **Allow engine to cool.**
 - **Keep flames and sparks away from fuel system service area. Keep area well ventilated.**
 - **Use cardboard to locate leaking hydraulic fluid under pressure.**
 - **Use TENNANT supplied or approved replacement parts.**

- 7. When loading/unloading machine onto/off truck or trailer:**
 - **Turn off machine.**
 - **Use truck or trailer that will support the weight of the machine.**
 - **Use winch. Do not drive the machine onto/off the truck or trailer unless the load height is 380 mm (15 in) or less from the ground.**
 - **Set parking brake after machine is loaded.**
 - **Block machine tires.**
 - **Tie machine down to truck or trailer.**

The following safety labels are mounted on the machine in the locations indicated. If these or any label becomes damaged or illegible, install a new label in its place.

EMISSIONS LABEL - LOCATED ON THE SIDE PANEL OF THE OPERATOR COMPARTMENT.



ENGINE FAN AND BELT LABEL - LOCATED ON THE RADIATOR SHROUD.



FOR SAFETY LABEL - LOCATED ON THE SIDE PANEL OF THE OPERATOR COMPARTMENT.

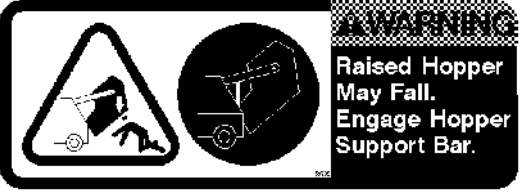
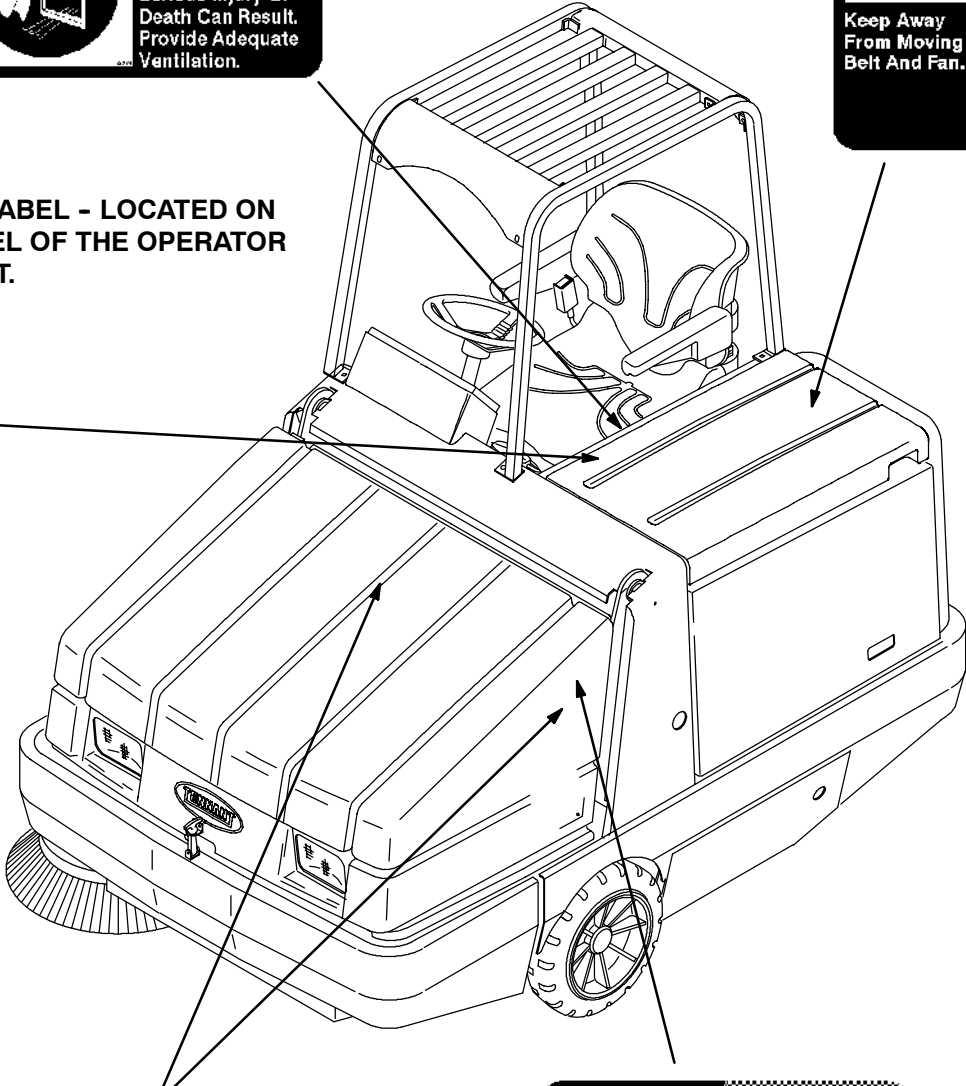

HOPPER SUPPORT BAR LABEL - LOCATED ON THE HOPPER SUPPORT BAR AND ON BOTH HOPPER LIFT ARMS.



HOPPER LIFT ARMS LABEL - LOCATED ON BOTH HOPPER LIFT ARMS.

354001

OPERATION

OPERATOR RESPONSIBILITY

- The operator's responsibility is to take care of the daily maintenance and checkups of the machine to keep it in good working condition. The operator must inform the service mechanic or supervisor when the required maintenance intervals occur as stated in the *MAINTENANCE* section of this manual.

- Read this manual carefully before operating this machine.

FOR SAFETY: Do not operate machine, unless operation manual is read and understood.

- Check the machine for shipping damage. Check to make sure machine is complete per shipping instructions.
- Check the hydraulic fluid level in the hydraulic reservoir.
- Check the engine oil level.
- Check the radiator coolant level.

FOR SAFETY: When servicing machine, avoid contact with hot engine coolant.

- Fill the fuel tank.

FOR SAFETY: When servicing machine, keep flames and sparks away from fuel system service area. Keep area well ventilated.

- After the first 50 hours of operation, follow the recommended procedures stated in the *MAINTENANCE CHART*.
- Keep your machine regularly maintained by following the maintenance information in this manual. We recommend taking advantage of a regularly scheduled service contract from your TENNANT representative.
- Order parts and supplies directly from your authorized TENNANT representative. Use the parts manual provided when ordering parts.

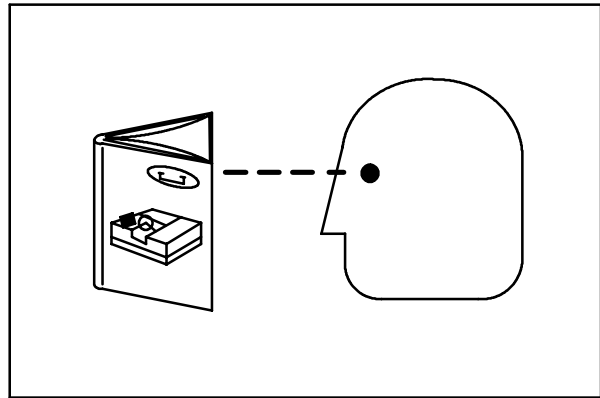

07324

OPERATION

MACHINE COMPONENTS

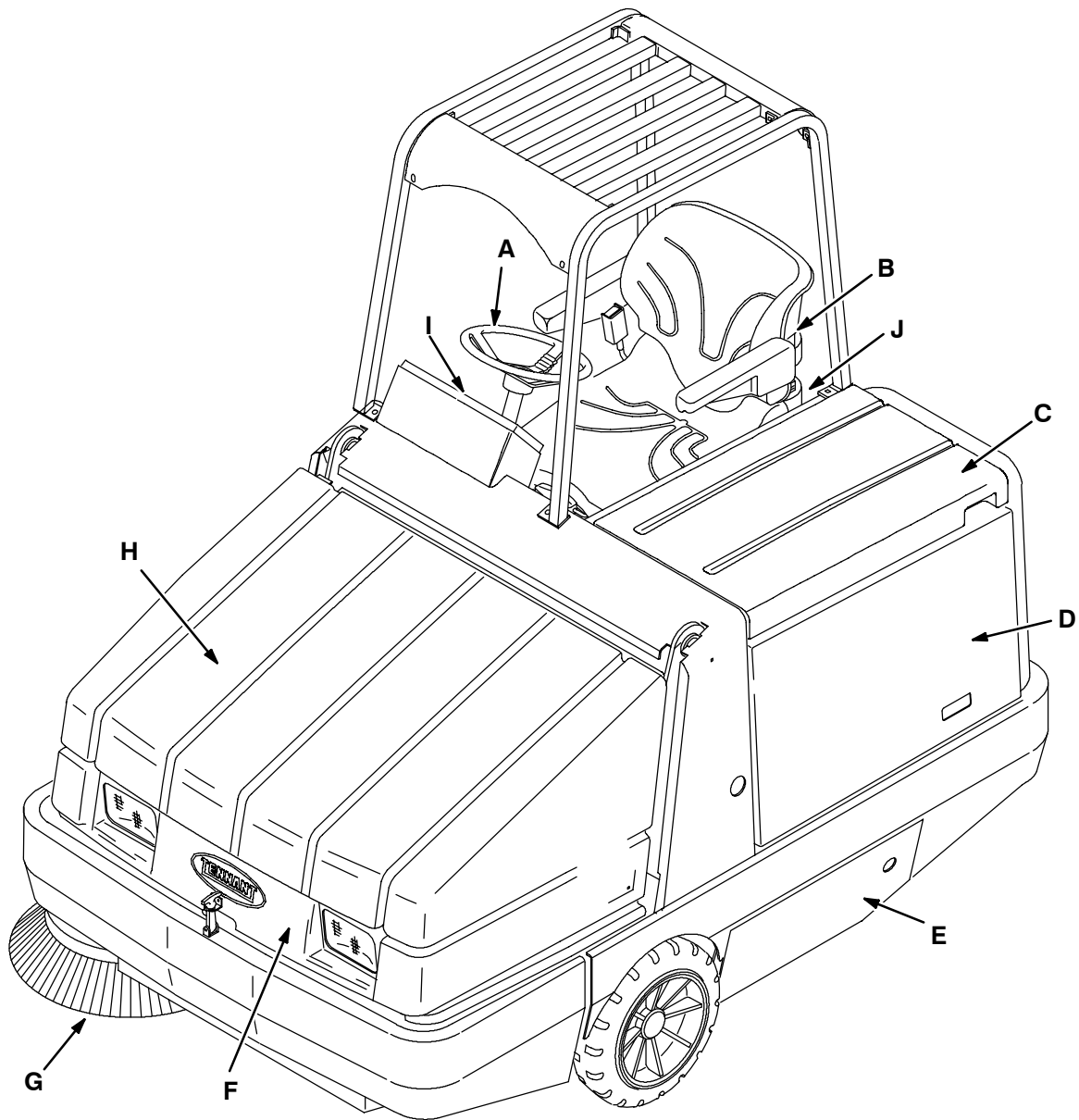

354001

- A. Steering Wheel
- B. Operator Seat
- C. Engine Cover
- D. Engine Side Door
- E. Main Brush Access Door
- F. Hopper Access Cover
- G. Side Brush
- H. Hopper Cover
- I. Instrument Panel
- J. Fuel Tank

CONTROL PANEL SYMBOLS

These symbols identify controls and displays on the machine:



Main Brush On



Main Brush Up



Horn



Hopper Door Open



Hopper Door Close



Hopper Down



Hopper Up



Filter Shaker



Side Brush



Vacuum Fan



Engine Speed



Low Engine Oil Pressure



High Engine Temperature



Main Broom Stall



Clogged Dust Filter



Thermo Sentry



Low Fuel



Alternator



Hazard Light



Operating Lights

OPERATION



Side Brush Down Pressure Light



Side Brush Down Pressure Heavy



Windshield Wiper Slow



Windshield Wiper Fast



Dome Light



Heater



Cab Pressurizer Slow



Cab Pressurizer Fast

CONTROLS AND INSTRUMENTS

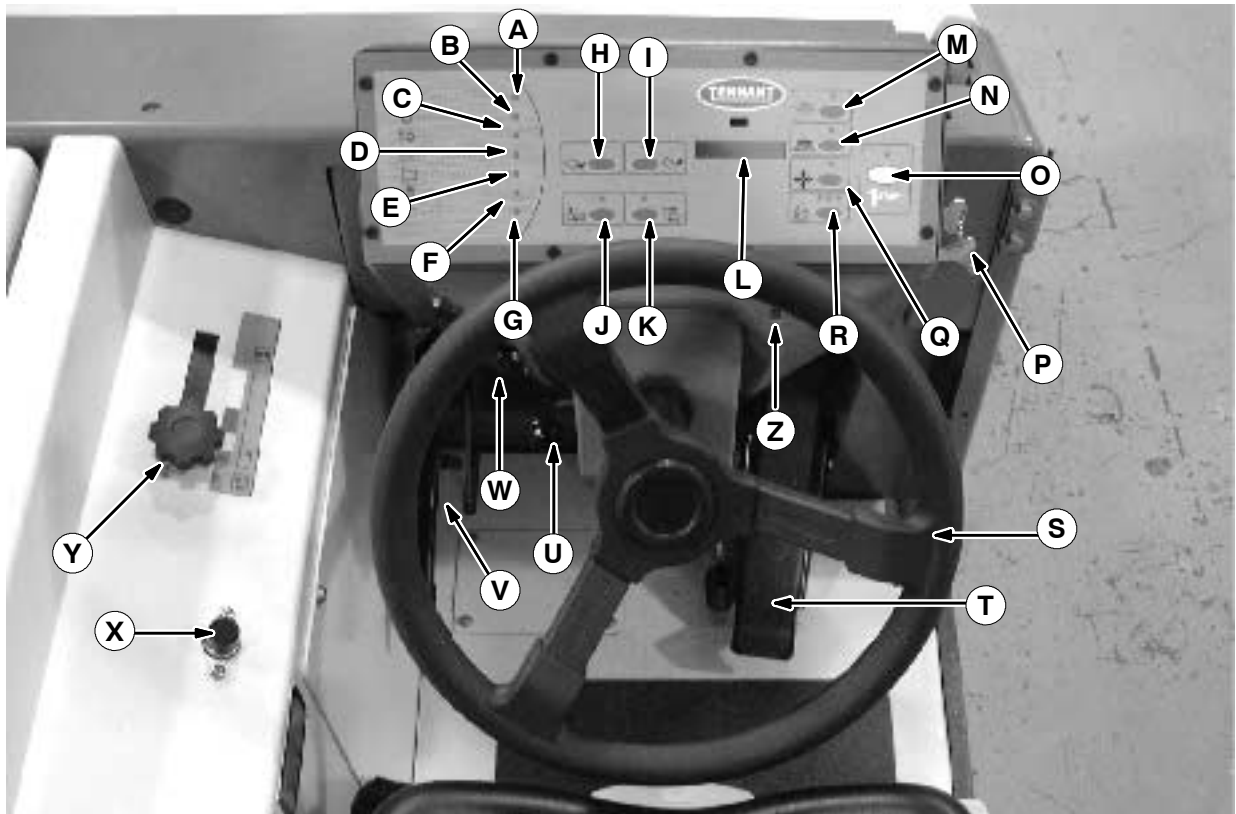

- A. Low Engine Oil Pressure Light
- B. High Engine Temperature Light
- C. Main Broom Stalled Light
- D. Clogged Dust Filter Light
- E. Thermo Sentry Light
- F. Low Fuel Light
- G. Alternator Light
- H. Hopper Close Switch
- I. Hopper Open Switch
- J. Hopper Down Switch
- K. Hopper Up Switch
- L. LCD Display
- M. Shake Filter Switch
- N. Side Brush Switch
- O. One Step Switch
- P. Ignition Switch
- Q. Vacuum Fan Switch
- R. Engine Speed Switch
- S. Steering Wheel
- T. Directional Pedal
- U. Steering Wheel Tilt Lever
- V. Parking Brake Lever
- W. Fuses
- X. Horn Button
- Y. Main Brush Adjustment Knob
- Z. Glow Plug Light

OPERATION

OPERATION OF CONTROLS

DIRECTIONAL PEDAL

The *directional pedal* controls direction of travel and the propelling speed of the machine. You change the speed of the machine with the pressure of your foot; the harder you press the faster the machine travels.

Forward: Press the top of the *directional pedal* with the toe of your foot.



Reverse: Press the bottom of the *directional pedal* with the heel of your foot.



Neutral: Take your foot off the *directional pedal* and it will return to the neutral position.



The toe angle of the directional pedal is adjustable. Remove the clevis pin, move the top of the pedal to the angle needed, and put the clevis pin through the adjustment holes.



BRAKE PEDAL

The *brake pedal* stops the machine.

Stop: Take your foot off the directional pedal and let it return to the neutral position. Step on the brake pedal.



PARKING BRAKE LEVER

The *parking brake lever* sets and releases the front wheel brakes.

Set: Pull the *parking brake lever* up.

FOR SAFETY: Before leaving or servicing machine; stop on level surface, set parking brake, turn off machine and remove key.

Release: Push the *parking brake lever* down.

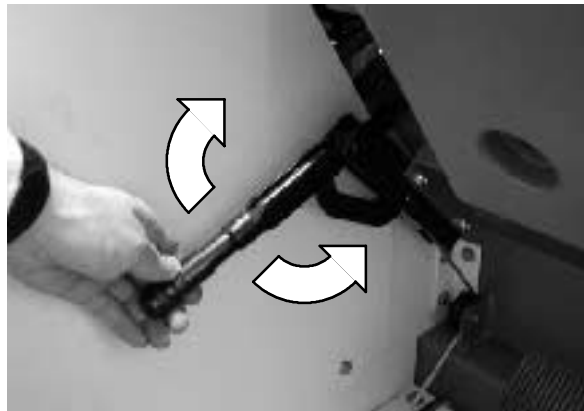

OPERATION

ONE STEP SWITCH

The *one step switch* controls the sweeping functions.

Start sweeping: Press the *one step switch*. The indicator light will illuminate. The engine speed will automatically increase to medium speed and the hopper door will open. The main sweeping brush and side brushes will lower and turn on and the vacuum fan will turn on.

NOTE: The hopper must be fully down, or the *one step switch* will not operate. If the hopper is up when the *one step switch* is activated, the hopper down light will blink, and the sweeping functions will not turn on.

NOTE: The *one step switch* will not operate if the thermo sentry senses excessive heat in the hopper. If the thermo sentry senses excessive heat in the hopper, the thermo sentry warning light will come on and the sweeping functions will not turn on.

Stop sweeping: Press the *one step switch*. The indicator light will turn off and the engine speed will stay at the selected speed (medium or high speed). The hopper door will automatically close. The main sweeping brush and side brushes will turn off, and raise to the up position. The vacuum fan will turn off and the filter shaker will activate for approximately 10 seconds.

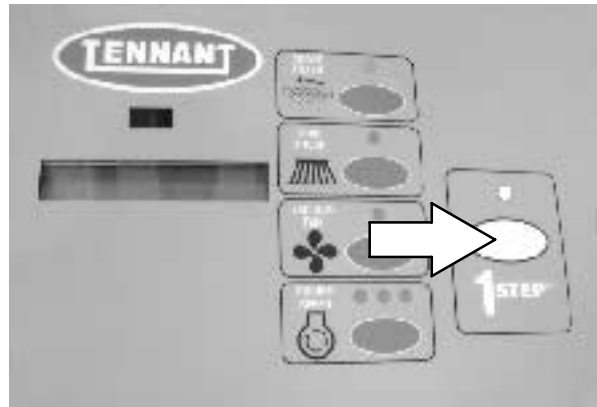

SHAKE FILTER SWITCH

The *shake filter switch* activates the filter shaker.

Shake filter: Press the *shake filter switch*. The indicator light will illuminate. The shaker will operate for approximately 10 seconds.

NOTE: The shaker will automatically activate after the vacuum fan is turned off.

NOTE: The shaker will automatically de-activate when the vacuum fan is turned on.

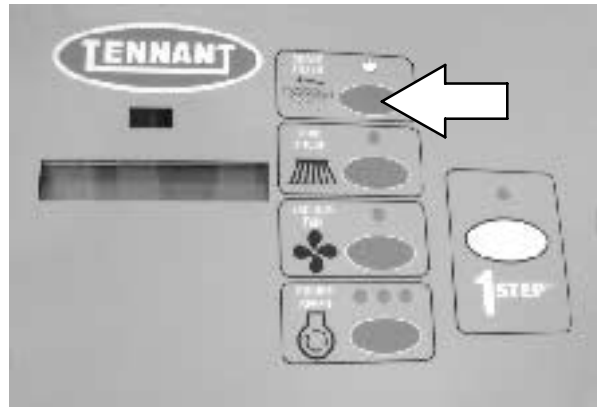

SIDE BRUSH SWITCH

The *side brush switch* controls the side brush position and rotation. The main brush must be operating for the side brush to work.

Down and On: Press the *side brush switch*. The indicator light will illuminate, and the side brush will turn on and lower to the down position.

Up and Off: Press the *side brush switch*. The indicator light will turn off, and the side brush will turn off and raise to the up position.

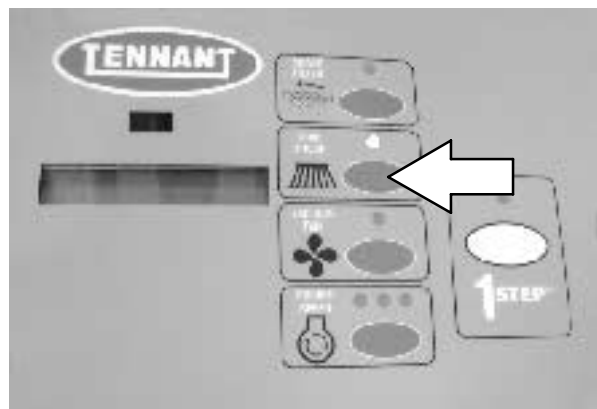

VACUUM FAN SWITCH

The *vacuum fan switch* activates the vacuum fan, so it can be used to operate the vacuum wand (vacuum wand mode) without the other sweeping functions.

Vacuum fan on: Press the *vacuum fan switch*. The indicator light will illuminate and the engine speed will set to **High** speed.

Vacuum fan off: Press the *vacuum fan switch*. The indicator light will turn off and the engine speed will set to **Low** speed.

NOTE: The shaker will automatically activate after the vacuum fan is turned off.

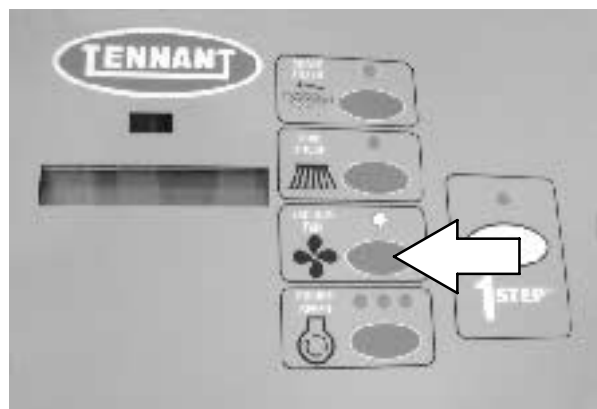

OPERATION

ENGINE SPEED CONTROL SWITCH

The engine *speed control switch* allows the operator to cycle through and choose from the three different engine speed settings; **Low**, **Medium**, and **High**.

Change engine speed: Press and hold the engine speed control switch. The machine will scroll through the three engine speeds continuously. Release the switch when the desired speed is chosen.

*NOTE: The sweeping functions will not operate with the **Low** engine setting.*

*NOTE: The engine speed will automatically set to the **Medium** engine speed when the one step functions are activated.*

*NOTE: The engine speed will automatically set to the **High** engine speed when the vacuum fan is activated without the one step switch.*

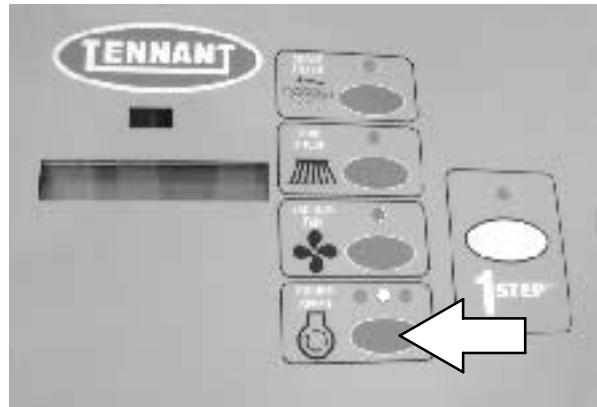

LCD DISPLAY

The *LCD display* is located in the middle of the control panel. The LCD display shows the hourmeter, fuel gauge and text messages to assist with machine maintenance.

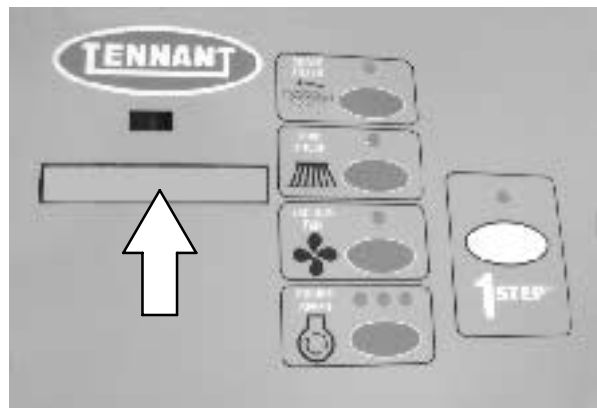

HOURMETER

The *hourmeter* is displayed on the right side of the LCD display. The *hourmeter* records the number of hours the machine has been operated. Use this information to determine machine maintenance intervals.

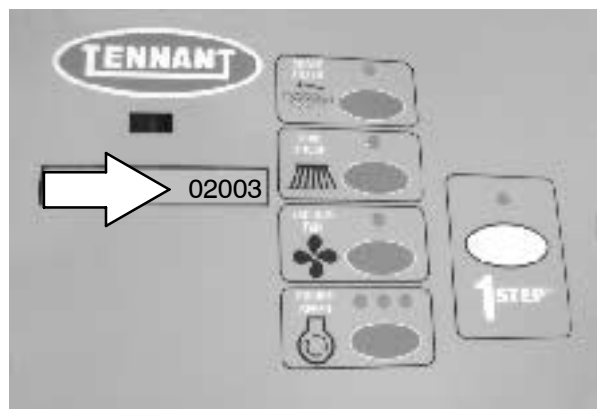

FUEL GAUGE

The fuel gauge is displayed by eight segments on the left side of the LCD display.

The fuel gauge shows all eight segments when the tank is full. The eight segments individually turn off as the tank empties. When all eight segments are off, the tank is almost out of fuel.

NOTE: When the tank is almost empty, the Low Fuel light will illuminate.

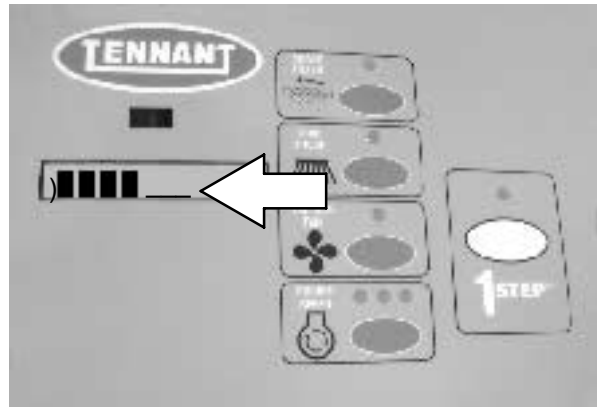

HOPPER OPEN SWITCH

The *hopper open switch* opens the hopper door and dust door. Open the hopper door when sweeping.

Open: Press the *hopper open switch*. The indicator light will illuminate, and the hopper door will open.

NOTE: The hopper door will automatically open when the One-Step switch is activated.

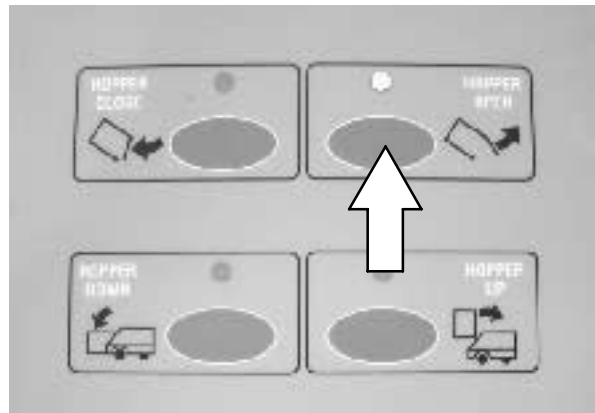

HOPPER CLOSE SWITCH

The *hopper close switch* closes the hopper door and dust door. Close the hopper door when emptying the hopper to control debris and dust.

Close: Press the *hopper close switch*. The indicator light will illuminate, and the hopper door will close.

NOTE: The hopper door will automatically close when the Thermo Sentry is activated.

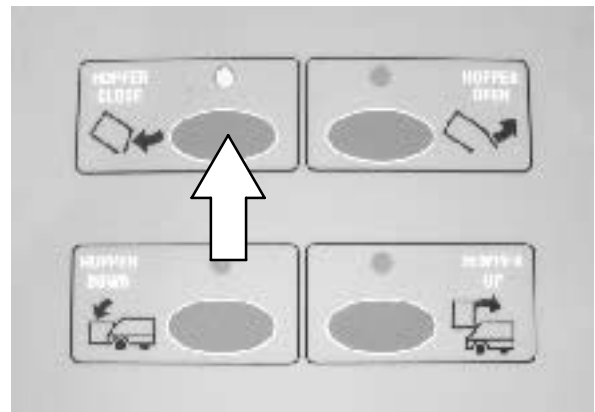

OPERATION

HOPPER UP SWITCH

The *hopper up switch* raises the hopper.

Up: Press and hold the *hopper up switch*. The indicator light will illuminate while the switch is pressed. Release the switch when the hopper is at the desired height.

 **WARNING: Raised hopper may fall.**
Engage hopper support bar.

NOTE: The One Step sweeping functions will stop when the hopper up switch is activated.

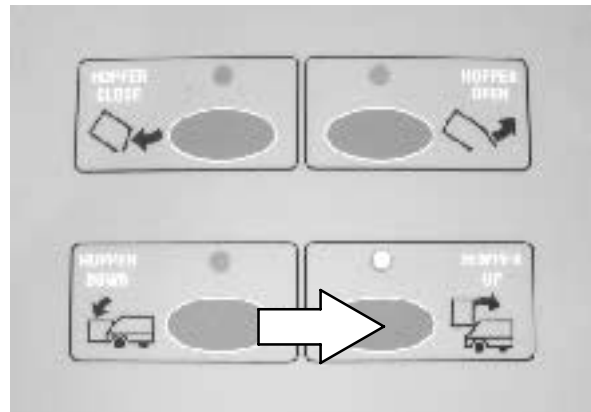

HOPPER DOWN SWITCH

The *hopper down switch* lowers the hopper.

Down: Press and hold the *hopper down switch*. The indicator light will illuminate while the switch is pressed. Release the switch when the hopper is all the way down in the lowered position.

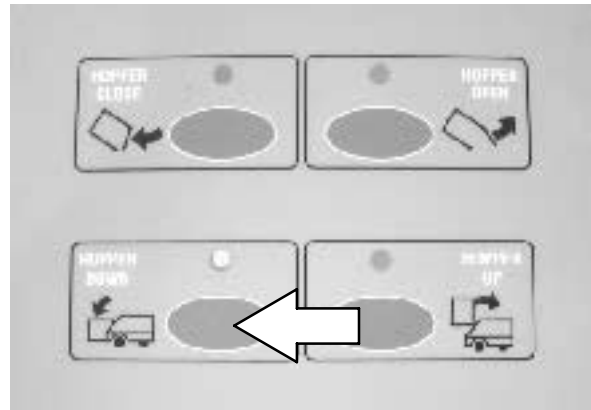

HORN BUTTON

The *horn button* operates the horn.

Sound: Press the button.



MAIN BRUSH ADJUSTMENT KNOB

The *main brush adjustment knob* controls the amount of contact the main brush has with the sweeping surface.

Note the length of the main brush bristles with the color band on the brush idler plate before moving the *main brush adjustment knob*.

Align the pointer from the plate located under the knob, to match the same color band as the brush idler plate.

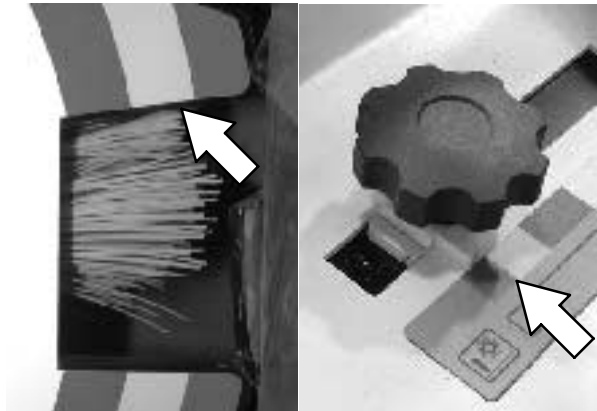

Loosen adjustment knob: Turn the adjustment plate knob counter-clockwise until the plate can slide along the adjustment panel.

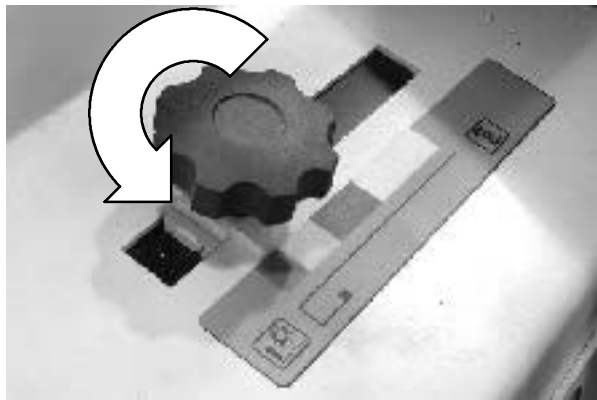

Secure adjustment knob: Turn the adjustment plate knob clockwise until the knob is hand tight and the plate cannot slide in the adjustment panel.

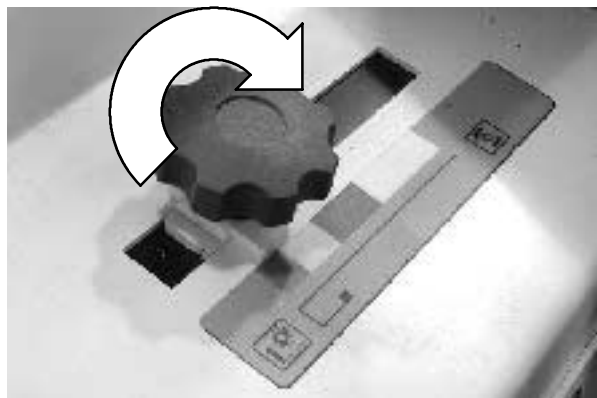

OPERATION

TURN SIGNAL SWITCH (OPTION)

The *turn signal switch* operates the turn signals.

Right: Push the switch lever forward.

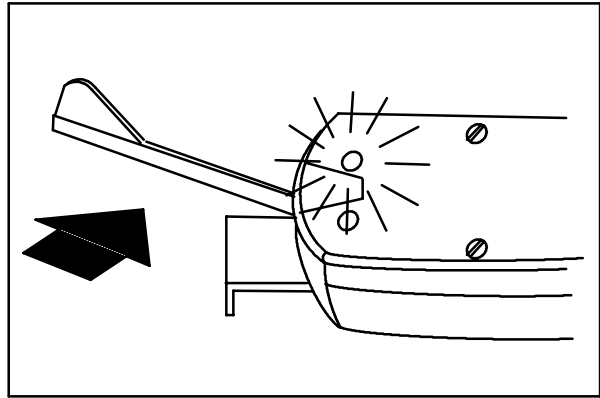

06487

Left: Pull the switch lever back.

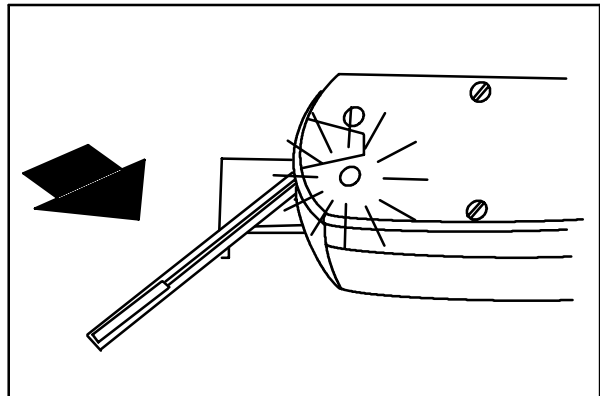

06488

Flashers: Pull out the knob.

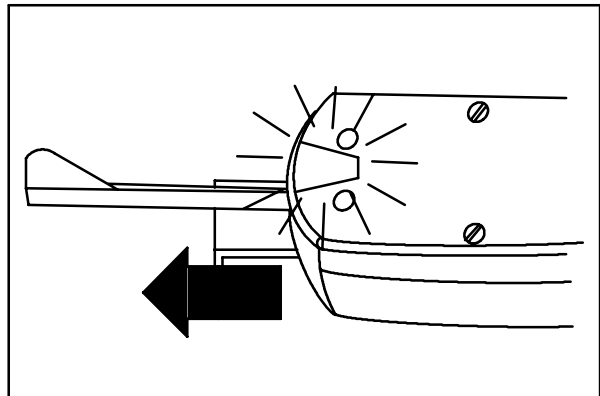

06745

LOW ENGINE OIL PRESSURE LIGHT

The *low engine oil pressure light* comes on when the engine oil pressure falls below 35 kPa (5 psi). The machine will shut down automatically, and “Check Engine” will be displayed on the LCD panel. Locate the problem and have it corrected.

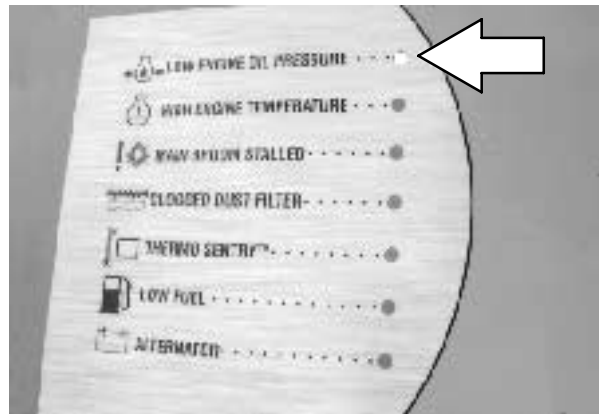

HIGH ENGINE TEMPERATURE LIGHT

The *high engine temperature light* comes on when the temperature of the engine coolant is more than 107° C (225° F). If the light comes on stop operating the machine. The “Check Engine” will be displayed on the LCD panel. Locate the problem and have it corrected.

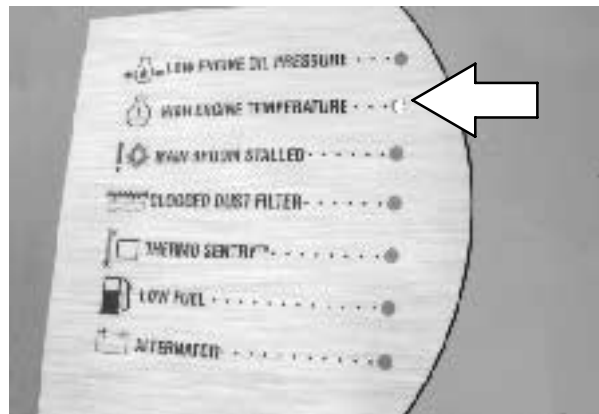

MAIN BRUSH STALLED LIGHT

The *main brush stalled light* comes on when the main brush is stalled. This can happen when an object is jammed in the main brush compartment, or when sweeping excessively heavy debris. Stop the machine, and remove the foreign object from the main brush compartment if necessary.

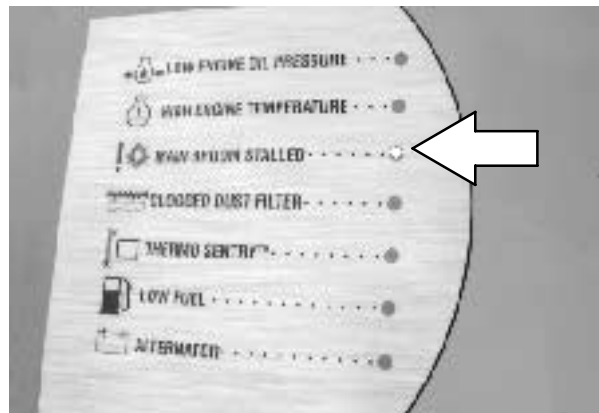

OPERATION

CLOGGED DUST FILTER LIGHT

The *clogged dust filter light* comes on when the hopper dust filter is clogged. To clean the filter, press the filter shaker switch. If the *clogged dust filter light* remains lit, manually clean the hopper dust filter. See *HOPPER DUST FILTER* in *MAINTENANCE*.

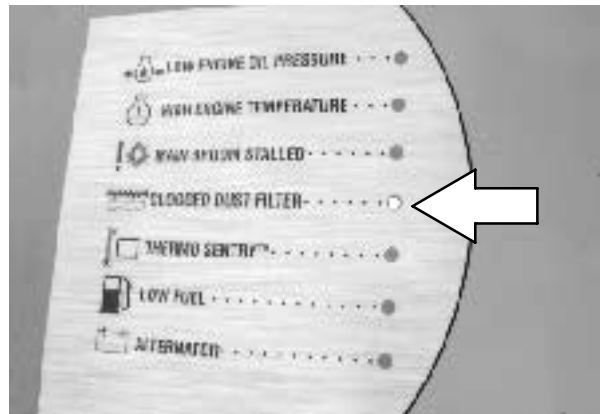

THERMO SENTRY LIGHT

The *thermo sentry light* comes on when there is too much heat in the hopper, possibly from a fire. The Thermo Sentry will stop the vacuum fan.

The Thermo Sentry has to be reset manually, see *THERMO SENTRY* in *MAINTENANCE*.

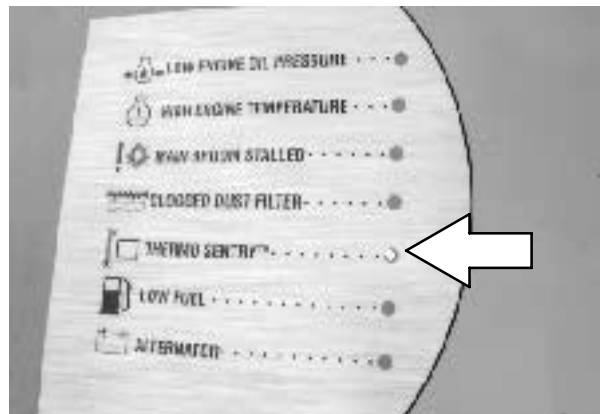

LOW FUEL LIGHT

The low fuel light comes on when the fuel tank is almost empty. Stop sweeping with the machine, and return the machine to the service area.

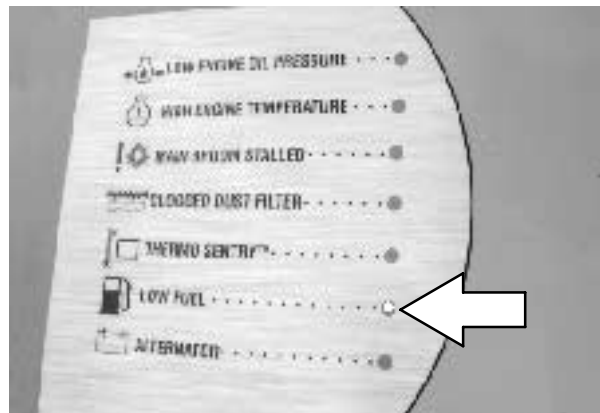

ALTERNATOR LIGHT

The *alternator light* comes on when the existing voltage potential of the battery is not within normal range - 10 to 14 Volts. Stop operating the machine. Locate the problem and have it corrected.

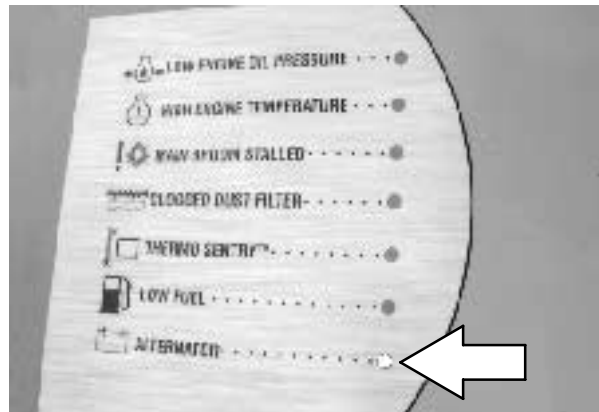
**GLOW PLUG LIGHT**

The *glow plug light* comes on when the ignition switch is turned counterclockwise to the preheat position.

**STEERING WHEEL**

The *steering wheel* controls the machine's direction. The machine is very responsive to the steering wheel movements.

Left: Turn the *steering wheel* to the left.

Right: Turn the *steering wheel* to the right.

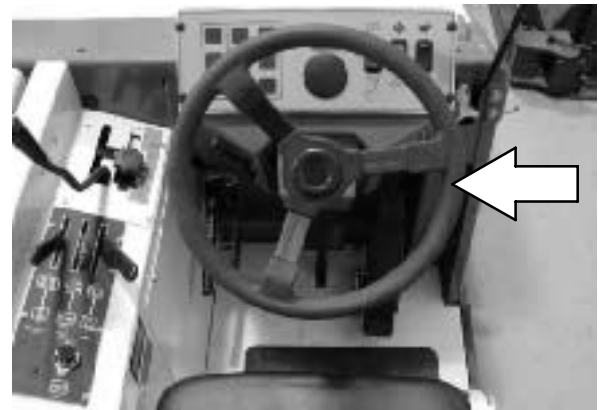
**STEERING COLUMN TILT LEVER**

The *steering column tilt lever* controls the angle of the steering column.

Adjust: Pull down on the tilt lever, move the column up or down, and release the tilt lever.

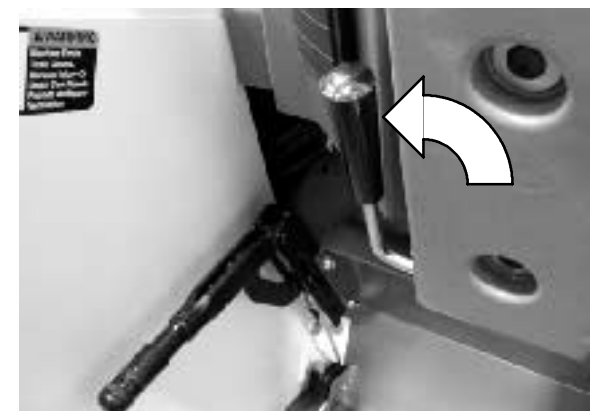

OPERATION

IGNITION SWITCH

The *ignition switch* starts and stops the engine with a key.

FOR SAFETY: When starting machine, keep foot on brake and directional pedal in neutral.

Preheat: Turn the key counter-clockwise. The glow plug light will come on. Hold the key in this position for 15 to 30 seconds, depending on weather conditions. Colder weather requires longer time.



Start: Turn the key all the way clockwise. Release the key as soon as the engine starts.

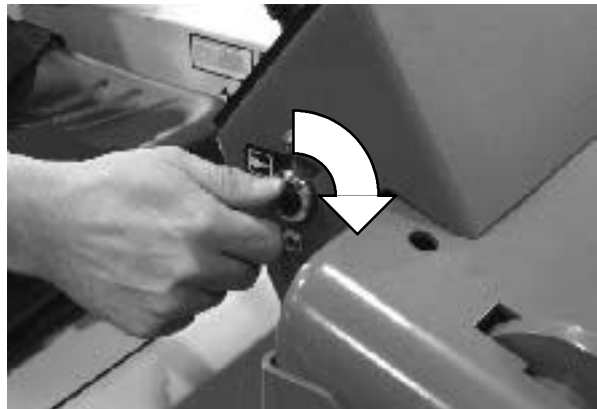

Stop: Turn the key counter-clockwise.



OPERATING/HAZARD LIGHTS SWITCH

The *operating/hazard light switch* powers on and off the operating/hazard lights (option).

Operating Lights On: Press the left side of the switch.

Operating/Hazard Lights On: Press the right side of the switch.

Off: Press the switch to the middle off position.

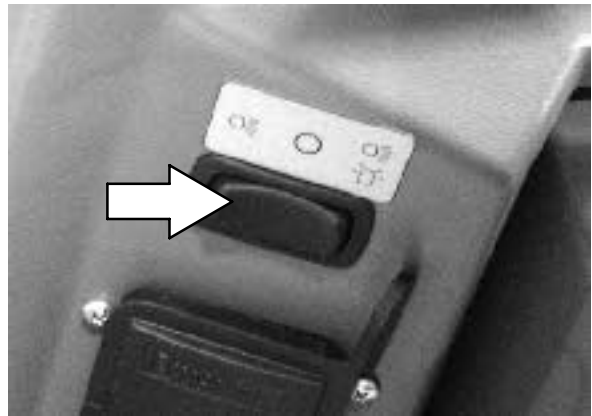
**SIDE BRUSH DOWN PRESSURE KNOB**

The *side brush down pressure knob* changes the side brush contact with the sweeping surface.

Heavy: Turn the *side brush down pressure knob* counter-clockwise.



Light: Turn the *side brush down pressure knob* clockwise.



OPERATION

FUSES

Fuses are a one-time protection device designed to stop the flow of current in the event of a circuit overload. Never substitute higher value *fuses* than specified.

Machine *fuses* are located on the left side of the operator compartment, under the steering column.

The chart lists the *fuses* and the electrical components they protect.

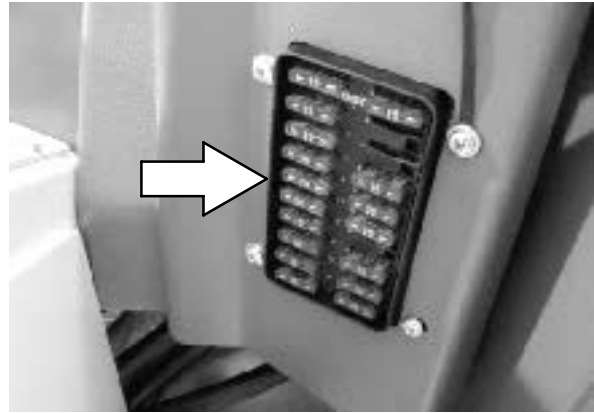

Fuses	Rating	Circuit Protected
F-1		Control Board
F-2		Open
F-3	15 A	Horn, Turn signals
F-4		Open
F-5	30 A	Key switch
F-6	15 A	Filter shaker
F-7	15 A	Cab options
F-8		Open
F-9	15 A	Brake lights
F-10	15 A	Cab pressurizer (option)
F-11	15 A	Engine control, auxiliary relays
F-12	15 A	Reverse switch
F-13	15 A	Auxiliary side brush (option)
F-14	15 A	Headlights, warning lights
F-15		Open
F-16		Open
F-17	15 A	Hydraulic solenoids
F-18		Open
F-19	15 A	Vacuum fan light, filter shaker light
F-20	15 A	Hydraulic solenoids

CIRCUIT BREAKERS (OPTION)

The circuit breakers are resettable electrical circuit protection devices. Their design stops the flow of current in the event of a circuit overload. Once a circuit breaker is tripped, it must be reset manually. Press the reset button after the breaker has cooled down.

If the overload that caused the circuit breaker to trip is still there, the circuit breaker will continue to stop current flow until the problem is corrected.

Both circuit breakers are located in the operator compartment, on the operator seat support.

The chart lists the circuit breakers and the electrical components they protect.

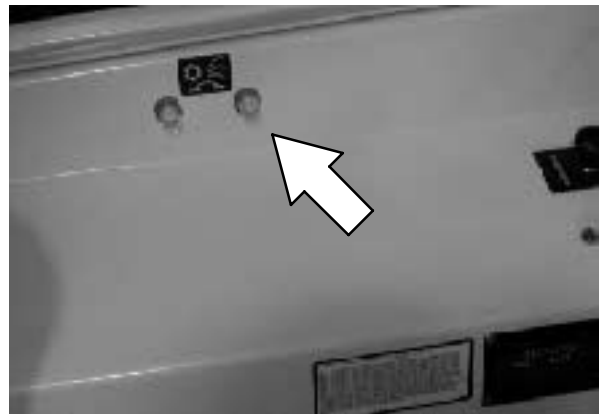

Circuit Breaker	Rating	Circuit Protected
CB-21	20 A	Air conditioner (option)
CB-22	20 A	Air conditioner (option)

OPERATION

LATCHES

The side doors, rear doors, engine cover, hopper cover, hydraulic tilt-out cooler, and cab door are secured with *latches*.

Open the right rear Grille Door: Pull the door open.

Open the left rear Grille Door: On machines serial number 009999 and below, push down on the door *latch*. On machines serial number 010000 and above, pull the door open.



Open the Main Brush Side Doors: Push down on the door *latch*.

Open the Cab Door: Pull up on the door handle.

Open the Engine Cover: Push in on the cover latch.

Open the Engine Side Door: Pull up on the door *latch*.

Open the Hopper Cover: Pull the rubber cover *latch* forward and pull up on the hopper cover.

Tilt out Hydraulic Cooler: On machines serial number 010000 and above, lift up on the rear of the latch and release the front of the latch from the catch.



HOPPER SUPPORT BAR

The *hopper support bar* is located on the operator's side of the hopper. The *hopper support bar* holds the hopper in the raised position to allow work under the hopper. DO NOT rely on the machine hydraulic system to keep the hopper raised.

 **WARNING: Raised hopper may fall. Engage hopper support bar.**



DELUXE SUSPENSION SEAT

The *deluxe suspension seat* has three adjustments. They are for backrest angle, operator weight adjustment and front to back adjustment.

The backrest angle adjustment lever adjusts the angle of the backrest.

Adjust: Raise the lever up and slide the seat backward or forward, until the backrest angle is in the desired position, and release the lever.



The front to back adjustment lever is located on the left hand side of the operator's seat.

Adjust: Pull the lever in, slide the seat forward or backwards to the desired position, and release the lever.

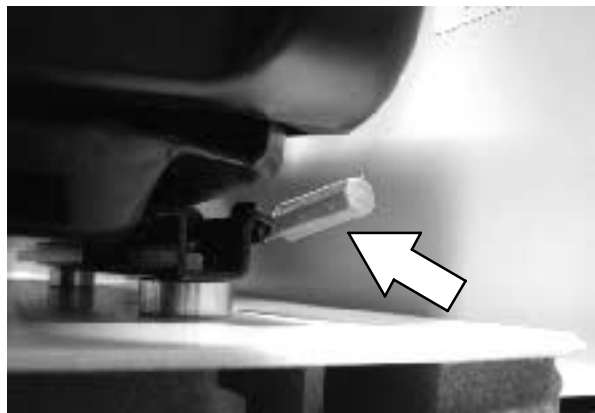

OPERATION

The weight adjustment lever controls the firmness of the operator's seat.



Lift: Pull up on the *operator seat* mounting plate until the seat mount locks up.

Lower: Pull on the release lever and lower the seat mounting plate.



HEATER KNOB (OPTION)

The *heater knob* controls the cab heater on the cab option.

On: Pull the knob out until the air temperature is at the desired comfort level. For maximum heat, pull the knob out all the way.

Off: Push the knob in all the way.

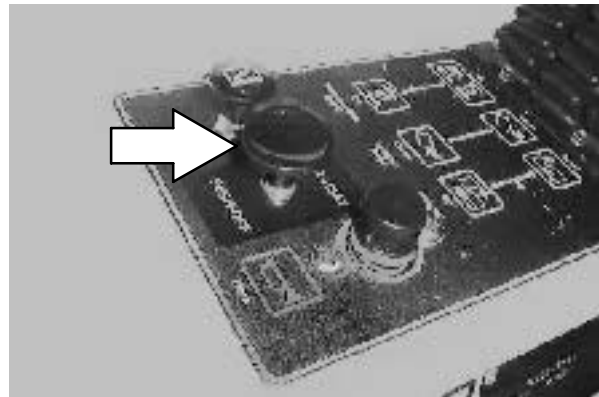
**AIR CONDITIONING SWITCH (OPTION)**

The air conditioning switch operates the cab's air conditioning in the optional cab.

On: Press the top of the switch.

Off: Press the bottom of the switch.

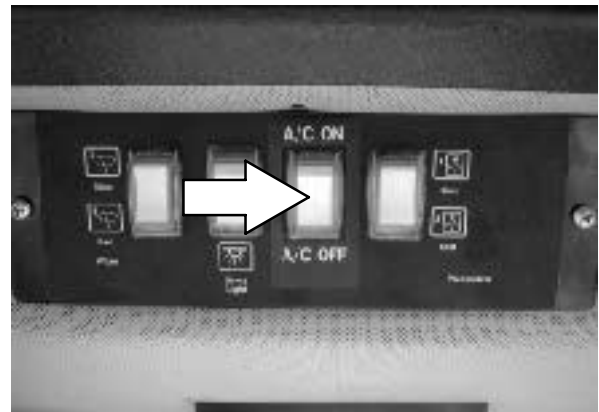
**WINDSHIELD WIPER SWITCH (OPTION)**

The *windshield wiper switch* operates the windshield wiper on the cab option. The wiper can be operated at two speeds.

Slow: Press the top of the switch.

Fast: Press the bottom of the switch.

Off: Return the switch to the middle position.

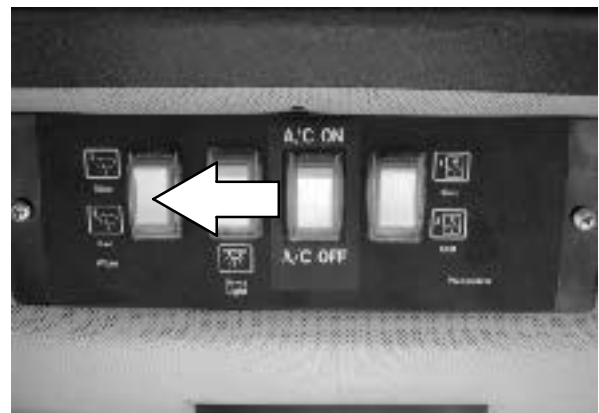

OPERATION

DOME LIGHT SWITCH (OPTION)

The *dome light switch* controls the dome light on the cab option.

On: Press the top of the switch.

Off: Press the bottom of the switch.

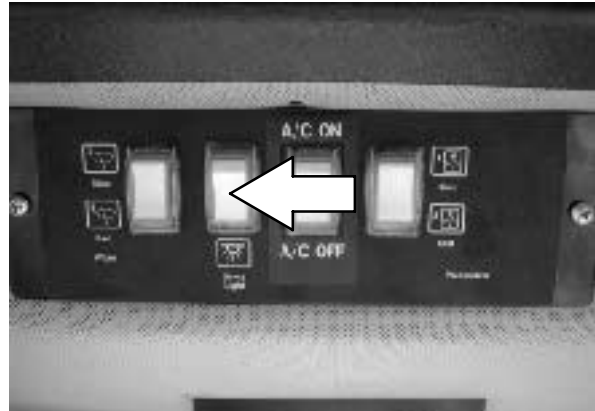

PRESSURIZER SWITCH (OPTION)

The *pressurizer switch* operates the cab pressurizer on the cab option. The pressurizer can be operated at two speeds.

Slow: Press the top of the switch.

Fast: Press the bottom of the switch.

Off: Return the switch to the middle position.



HOW THE MACHINE WORKS

The steering wheel controls the direction of machine travel. The directional pedal controls the speed and forward/reverse direction. The brake pedal slows and stops the machine.

The side brush sweeps debris into the path of the main brush. The main brush sweeps debris from the floor into the hopper. The vacuum system pulls dust and air through the hopper and the hopper dust filter.

When sweeping is finished, clean the hopper dust filter and empty the hopper.

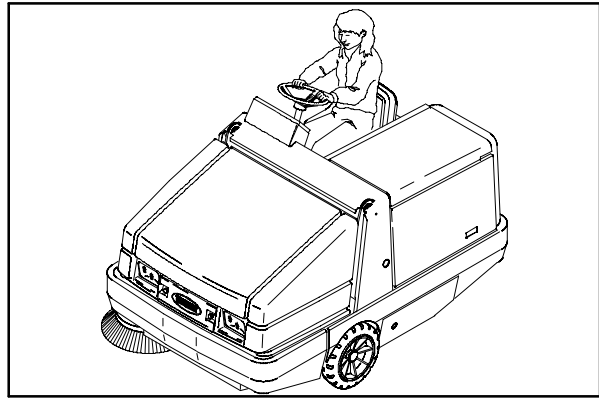

07816

PRE-OPERATION CHECKLIST

- Check the engine oil level.
- Check the engine coolant level.
- Check the radiator and hydraulic cooler fins for debris.
- Check the hydraulic fluid level
- Check the skirts and seals for damage and wear.
- Check the condition of the sweeping brushes. Remove any string, banding, plastic wrap, or other debris wrapped around them
- Check the sweeping brush patterns for adjustment.
- Check the condition of the hopper dust filter and seals. Clean as required.
- Check the brakes and steering for proper operation.
- Check the fuel level.
- Check the service records to determine if maintenance is needed.

STARTING THE MACHINE

1. You must be in the operator's seat with the directional pedal in neutral, and your foot on the brake pedal or with the parking brake set.

For Safety: When starting machine, keep foot on brake and directional pedal in neutral.



2. Turn the key counter-clockwise. The glow plug light will come on. Hold the key in this position for 15 to 30 seconds, depending on weather conditions. Colder weather requires longer time.



3. Turn the ignition switch key clockwise until the engine starts.

NOTE: Do not operate the starter motor for more than 10 seconds at a time or after the engine has started. Allow the starter to cool between starting attempts or damage to the starter motor may occur.



WARNING: Engine emits toxic gases. Severe respiratory damage or asphyxiation can result. Provide adequate ventilation. Consult with your regulatory authorities for exposure limits. Keep engine properly tuned.

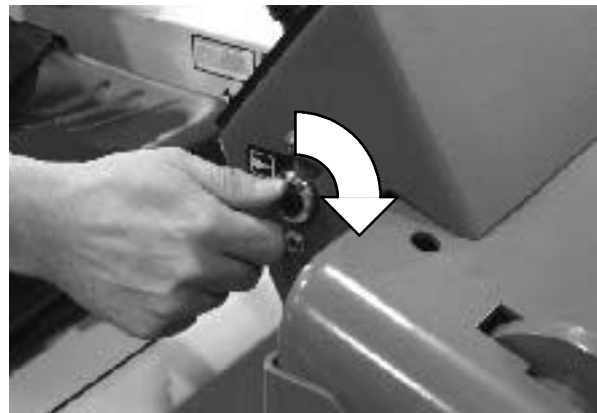

4. Release the machine parking brake.



5. Select the medium engine speed with the engine speed switch.

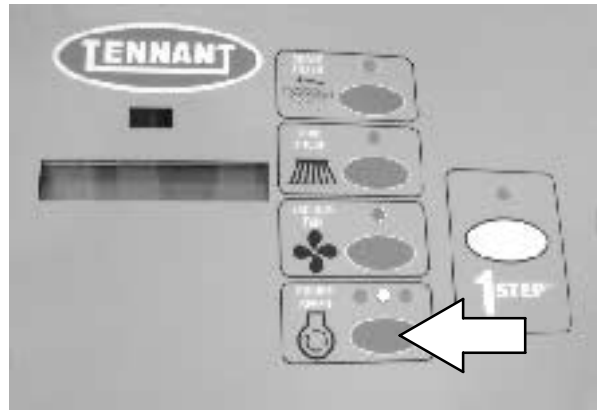

6. Drive the machine to the area being swept.

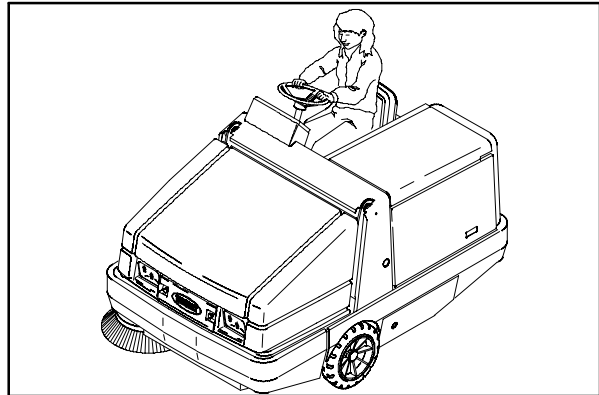

07816

SWEEPING AND BRUSH INFORMATION

Pick up oversized debris before sweeping. Flatten or remove bulky cartons from aisles before sweeping. Pick up pieces of wire, twine, string, etc., which could become entangled in brush or brush plugs.

Plan the sweeping in advance. Try to arrange long runs with minimum stopping and starting. Sweep debris from very narrow aisles into main aisles ahead of time. Do an entire floor or section at one time. Sweep as straight a path as possible. Avoid bumping into posts or scraping the sides of the sweeper. Overlap the brush paths.

Avoid turning the steering wheel too sharply when the machine is in motion. The machine is very responsive to the movement of the steering wheel. Avoid sudden turns, except in emergencies.

Speed up the engine to **Fast** engine speed when picking up light litter. This will improve both litter pickup and hopper loading. Do not use the **Fast** engine speed in dusty environments. The machine can dust and clog the hopper dust filter. Operate the engine in the **Medium** engine speed when picking up general debris.

For best results, use the correct brush type for your sweeping application. The following are recommendations for main and side brush applications.

Nylon 8-double Row Main Brush -

Recommended for general sweeping, and has good hopper loading. Nylon has the longest life of the bristle types. Use this brush for sweeping rough or irregular surfaces.

Polypropylene and Wire 8-double Row Main Brush - The wire bristles loosen slightly packed soilage and heavier debris. The polypropylene bristles sweep up the debris with excellent hopper loading.

Crinkle Wire 8-double Row Main Brush - The stiff wire bristles cut through compacted grime, hard to sweep dirt, and dirt mixed with oil, grease, or mud. This brush is recommended for foundry sweeping where heat may melt synthetic bristles. This brush has good hopper loading ability, but is not recommended for dusty applications.

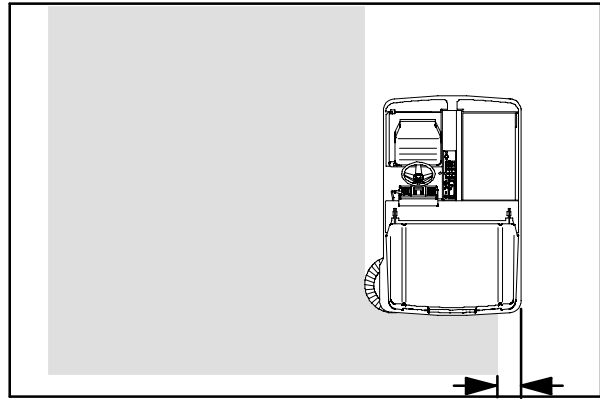

07817

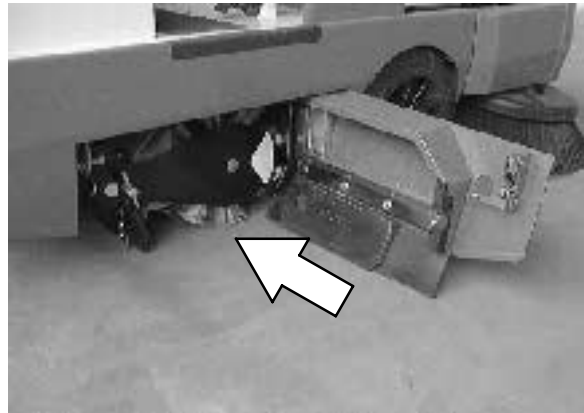

Nylon 24-row Main Brush - Recommended for severe dust conditions on rough surfaces. This brush has excellent pickup and long life.

Fiber and Wire 24-row Main Brush - Offers good sweeping action and pickup in heavy dust concentrations. This brush is recommended where soilage is slightly encrusted. The brush is not recommended for heavy buildup or hard packed soilage.

Polypropylene Side Brush - A good general purpose brush for sweeping of light to medium debris in both indoor and outdoor applications. This brush is recommended when bristles may get wet.

Nylon Side Brush - A longer life, general purpose brush that is recommended for rough surfaces.

Flat Wire Side Brush - Recommended for outside and curb-side sweeping where soilage is heavy or compacted. The stiff wire bristles dig out soilage. This brush is also recommended for foundry sweeping where heat may melt synthetic bristles.



SWEEPING

1. Press the one step switch to start sweeping.

The engine speed will automatically increase to medium speed and the hopper door will open. The main sweeping brush and side brushes will lower and turn on and the vacuum fan will turn on.

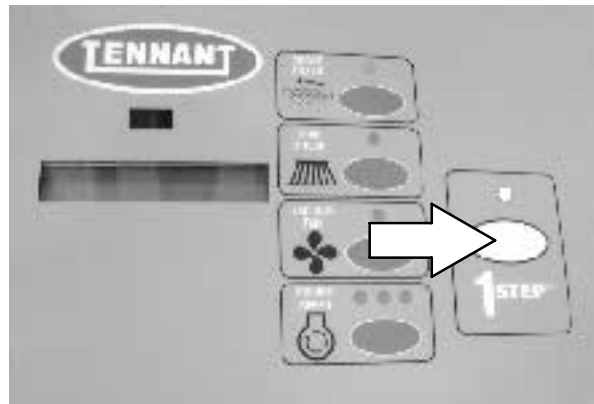

OPERATION

2. Press the side brush switch to stop or restart the side brush any time while sweeping.

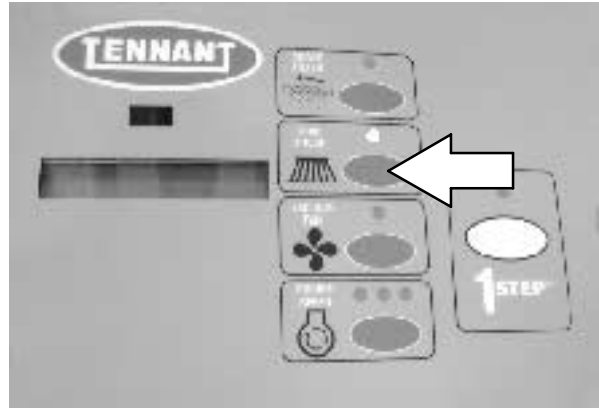

3. Adjust engine speed according to sweeping application.

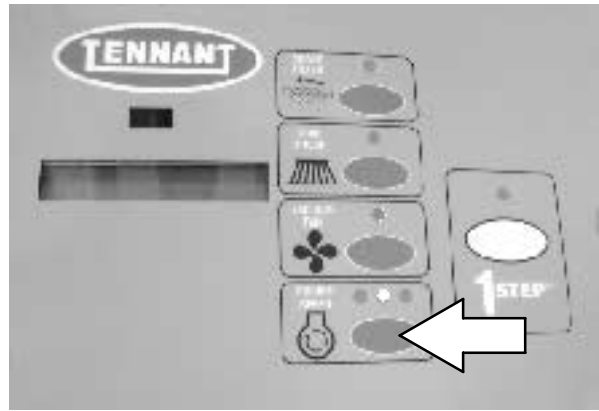

4. Sweep as needed.

STOP SWEEPING

1. Press the one step switch to stop sweeping.

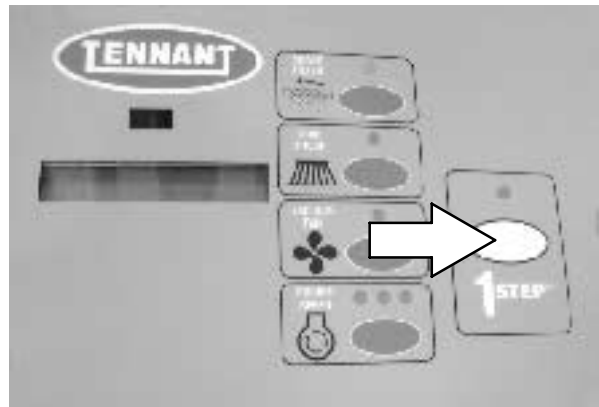

EMPTYING THE HOPPER

1. Slowly drive the machine to the debris site or debris container.

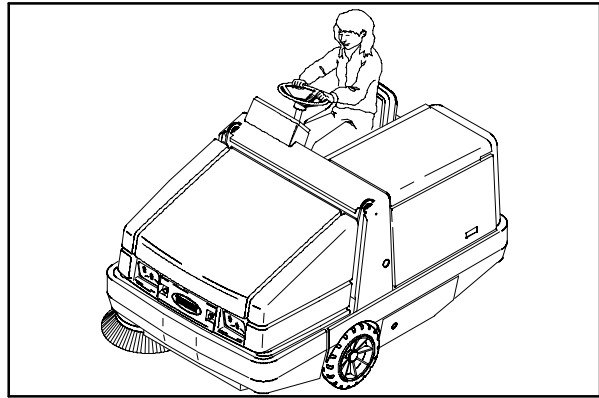

07816

2. Check the hopper close switch to make sure the debris hopper is closed.

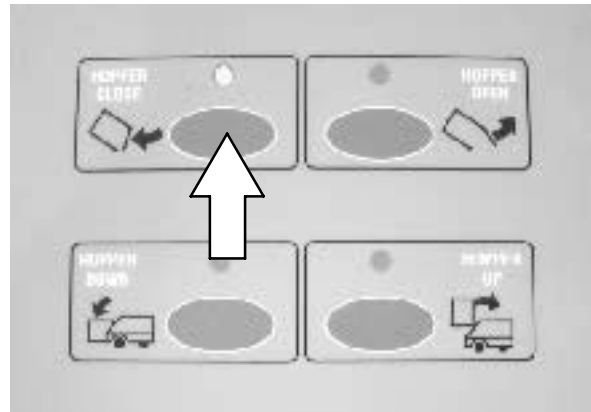

3. Press and hold the hopper up switch, and raise the hopper to the desired height.

FOR SAFETY: When using machine, make sure adequate clearance is available before raising hopper.

NOTE: Be aware that the minimum ceiling height needed to high dump the hopper is 2745 mm (9 ft.).

FOR SAFETY: When using machine, move machine with care when hopper is raised.

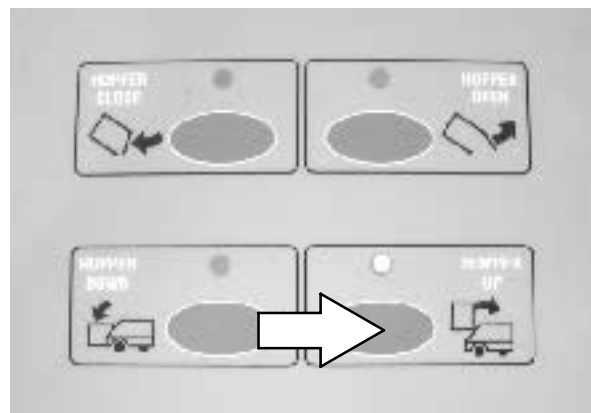

OPERATION

4. Drive the machine up to the debris container.
5. Press and hold the hopper down switch. Lower the hopper into the debris container to control dust. Release the switch when the hopper is at the desired height.

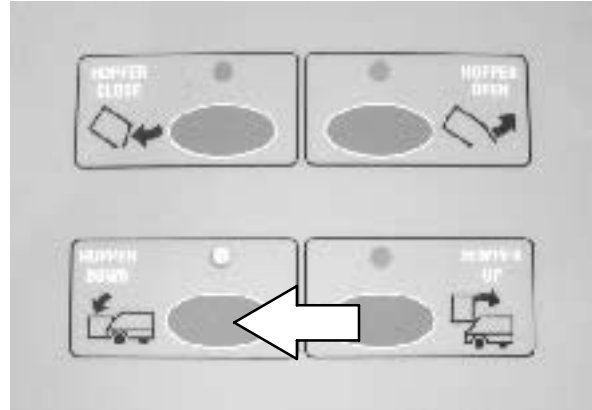

6. Press the hopper open switch to open the debris hopper.

7. Raise the hopper enough and/or close the hopper door to clear the top of the debris container.

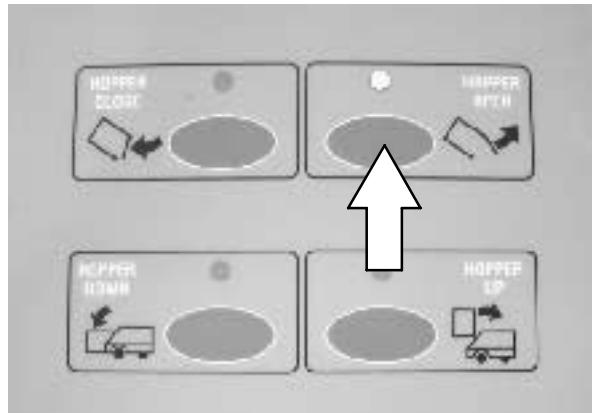

8. Slowly back the machine away from the debris site or debris container.

For Safety: When using machine, use care when reversing machine.

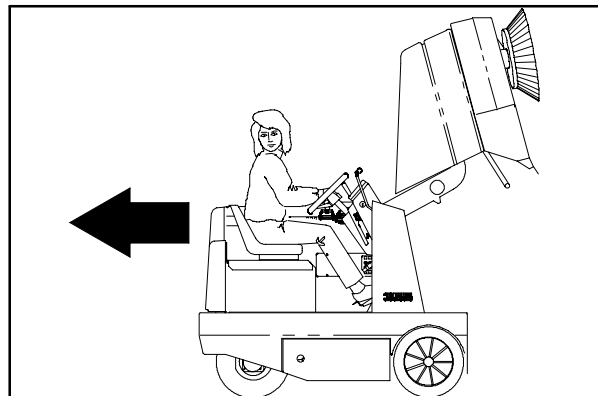

07996

9. Press and hold the hopper down switch until the hopper is all the way in the down position.

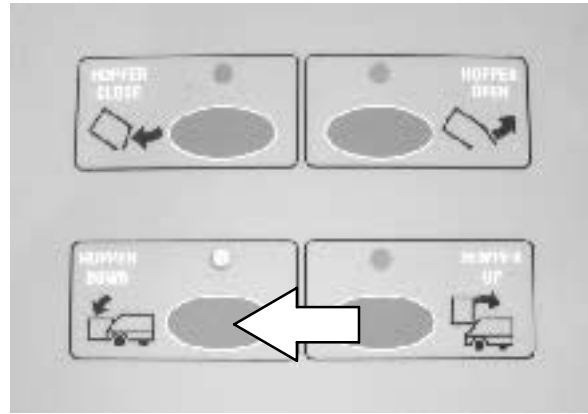

STOP THE MACHINE

1. Stop sweeping.
2. Take your foot off the directional pedal. Step on the brake pedal.



3. Select the low (Idle) position with the engine speed switch.

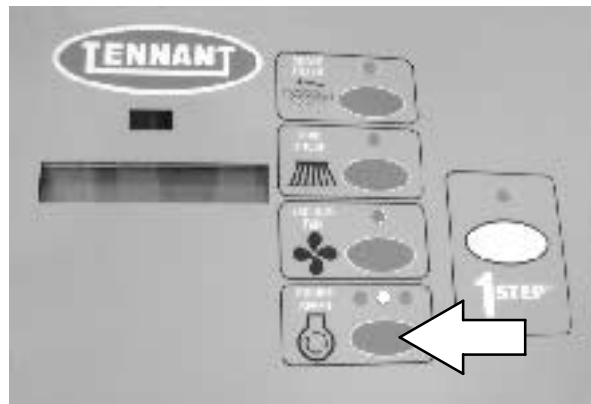

OPERATION

4. Set the machine parking brake.
5. Turn the ignition switch key counter-clockwise to stop the engine. Remove the switch key.

FOR SAFETY: Before leaving or servicing machine; stop on level surface, set parking brake, turn off machine and remove key.



POST-OPERATION CHECKLIST

- Check the engine oil level.
- Check the engine coolant level.
- Check the radiator and hydraulic cooler fins for debris.
- Check the hydraulic fluid level
- Check the air filter indicator.
- Check the skirts and seals for damage and wear.
- Check the condition of the sweeping brushes. Remove any string, banding, plastic wrap, or other debris wrapped around them
- Check the sweeping brush patterns for adjustment.
- Check the brakes and steering for proper operation.
- Check the fuel level
- Check the service records to determine maintenance requirements.

ENGAGING HOPPER SUPPORT BAR

1. Set the machine parking brake.

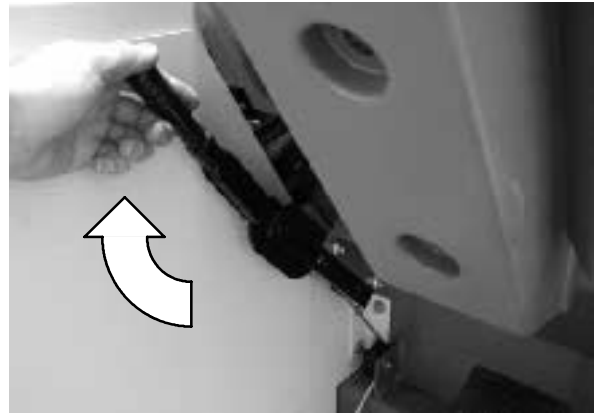

2. Start the engine.

For Safety: When starting machine, keep foot on brake and directional pedal in neutral.

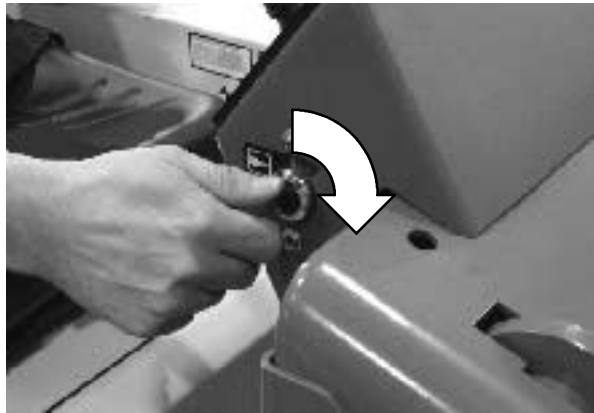

3. Press and hold the hopper up switch to raise the hopper. Release the switch when the hopper is all the way up.

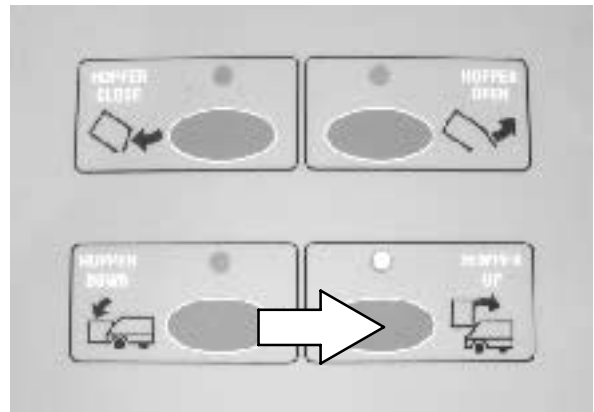

OPERATION

4. Lift and position the hopper support bar under the hopper lift arm.

 **WARNING: Raised hopper may fall. Engage hopper support bar.**



5. Press and hold the the hopper down switch, until the hopper lift arm rests on the support bar.

 **WARNING: Lift arm pinch point. Stay clear of hopper lift arms.**

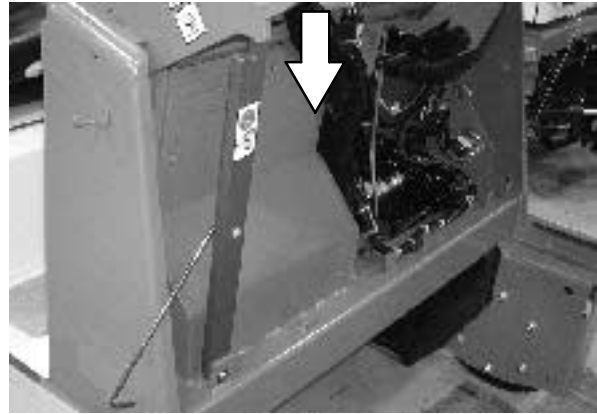

6. Shut the engine off.



DISENGAGING HOPPER SUPPORT BAR

1. Start the engine.

FOR SAFETY: When starting machine, keep foot on brake and directional pedal in neutral.

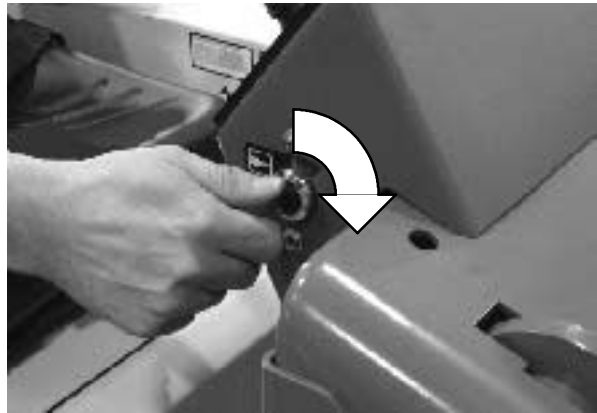

2. Press and hold the hopper up switch to raise the hopper up, off the hopper support bar.

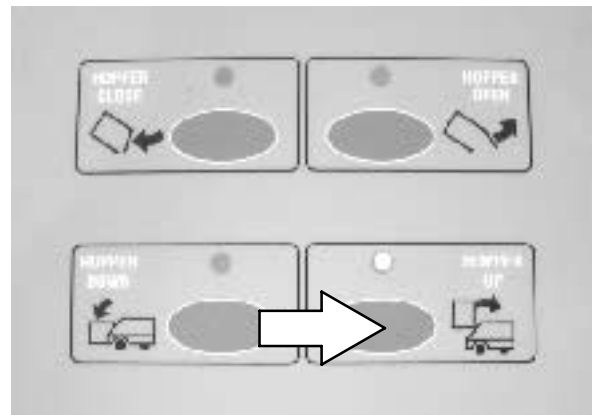

3. Put the support bar in its storage position.

 **WARNING:** Lift arm pinch point. Stay clear of hopper lift arms.



OPERATION

4. Press and hold the hopper down switch until the hopper is all the way down in the lowered position.

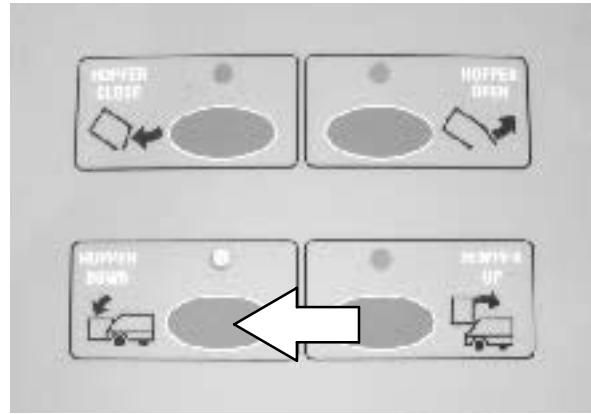

5. Shut the engine off.



OPERATION ON INCLINES

Drive the machine slowly on inclines. Use the brake pedal to control machine speed on descending inclines.

The maximum rated incline is 6°.

FOR SAFETY: When using machine, go slow on inclines and slippery surfaces.

OPTIONS

VACUUM WAND

The vacuum wand uses the machine's vacuum system. The vacuum hose and wand allow the operator to pick-up debris that is out of reach of the machine's sweeping path.

The vacuum wand can be used from the operator's seat while the machine is stopped. Do not operate the vacuum wand while driving the machine.

⚠ WARNING: Accident may occur. Do not operate vacuum or blower wand while driving.

1. Stop the machine within reach of the area to be vacuumed.
2. Shut the engine off.
3. Set the machine parking brake.

FOR SAFETY: Before leaving or servicing machine; stop on level surface, set parking brake, turn off machine and remove key.

4. Release the rubber strap(s) from the top edge of the vacuum hose.
5. On machines without a cab, lift the hose handle off the support hook and remove the hose end from the support hook.

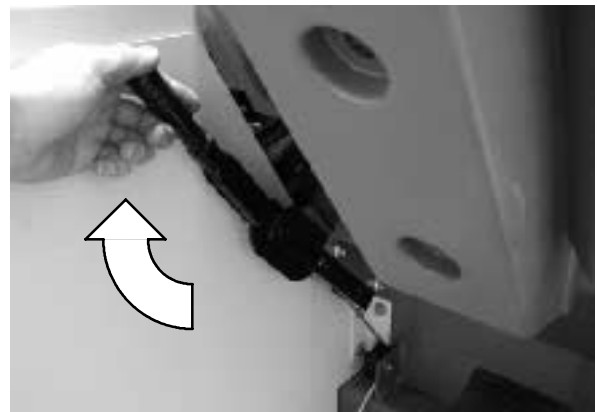

OPERATION

6. Open the vacuum wand door on the front of the machine hopper. Align the slot in the vacuum hose with the pin inside the vacuum door. Install the end of the vacuum hose in the machine.

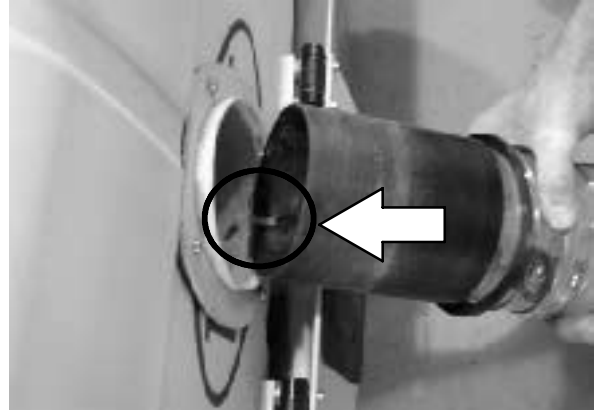

7. On machines without a cab, disconnect the rubber straps securing the solid section of vacuum hose to the machine.

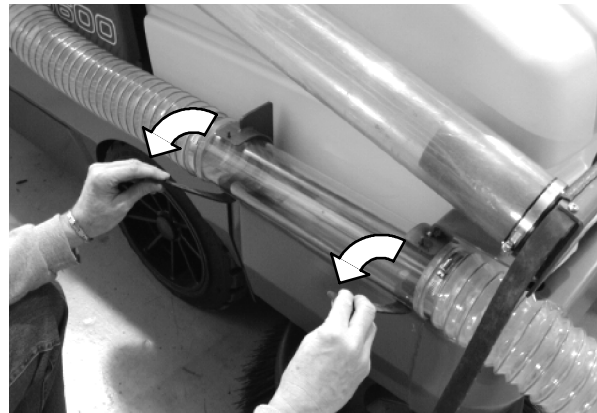

On machines with a cab, disconnect the rubber straps securing the vacuum hose handle to the machine.

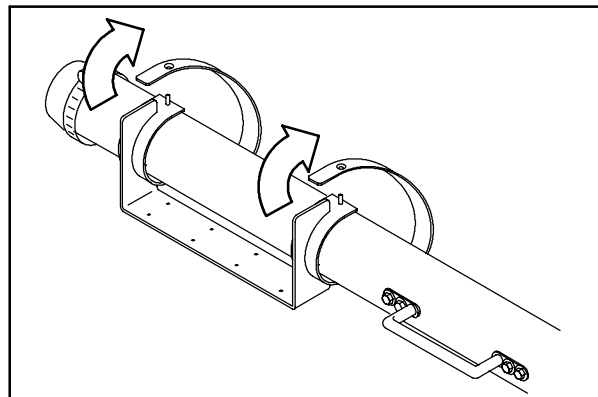

8. Start the engine.

FOR SAFETY: When starting machine, keep foot on brake and directional pedal in neutral.

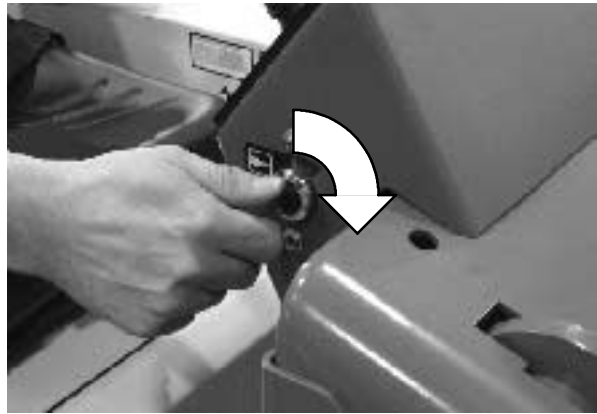

9. Press the vacuum fan switch, to start the vacuum fan.

The engine speed will set to the high speed, and the hopper door will automatically close.

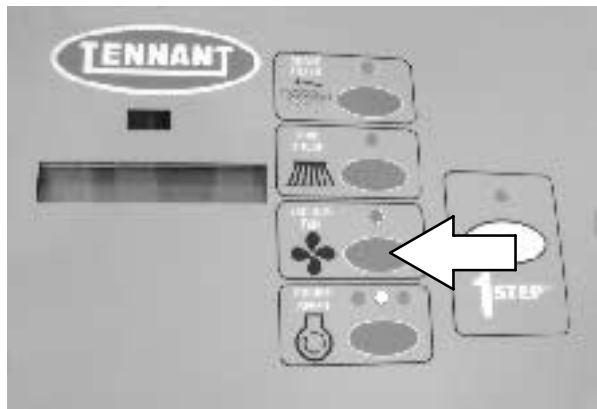

10. Vacuum the area as needed.

⚠ WARNING: Accident may occur. Do not operate vacuum or blower wand while driving.



OPERATION

11. Press the vacuum fan switch, to shut off the vacuum fan. The engine speed will set to medium speed.

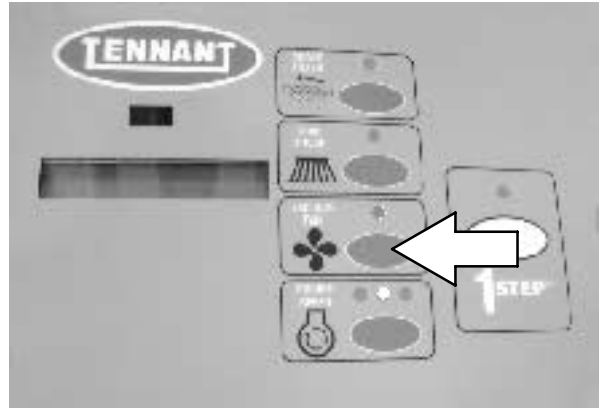

12. Shut the engine off.



13. Remove the vacuum hose from the hopper connection and close the vacuum wand door.
14. Secure the vacuum wand and hose in place with the mounting clips and rubber strap(s).

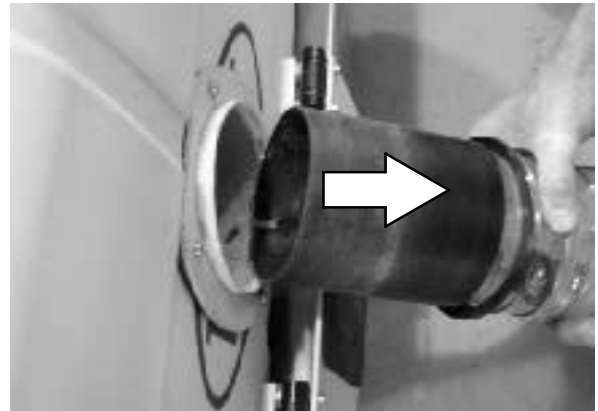

BLOWER WAND

The blower wand uses the machine's vacuum exhaust. The blower wand allows the operator to blow debris out from areas that are out of reach of the machine's sweeping path.

The blower wand can be used from the operator's seat while the machine is stopped. Do not operate the blower wand while driving the machine.

⚠ WARNING: Accident may occur. Do not operate vacuum or blower wand while driving.

1. Remove the blower attachment from the back of the machine.

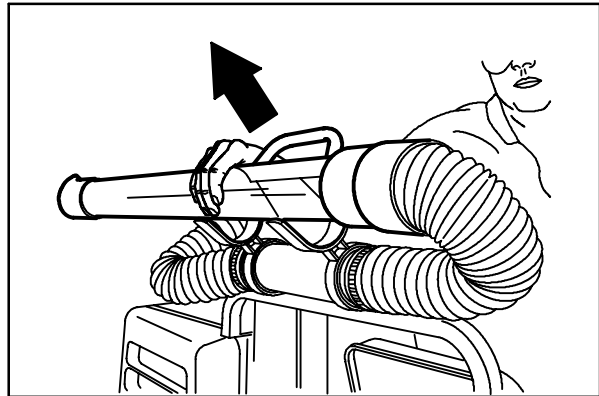

08142

2. Move the lever on the engine cover forward into the **ON** position to start airflow through the wand.

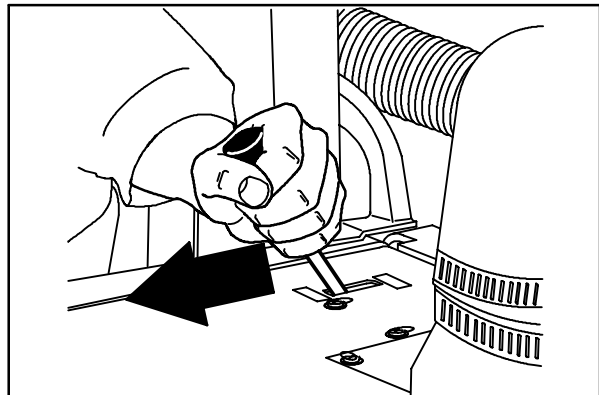

08144

3. Direct the wand into the area of debris.

The operator can rest the wand on the side bracket.

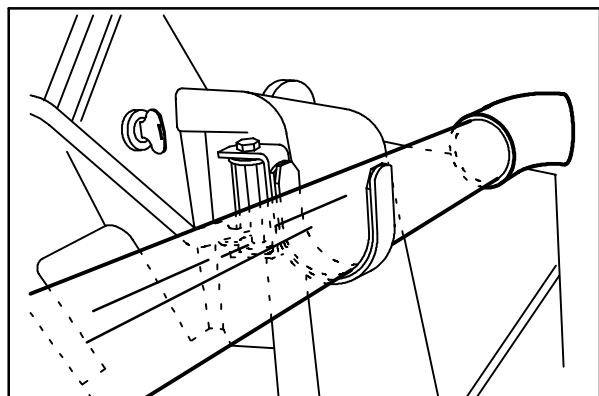

08147

OPERATION

4. Move the lever on the engine cover backward into the **OFF** position to stop airflow through the wand.

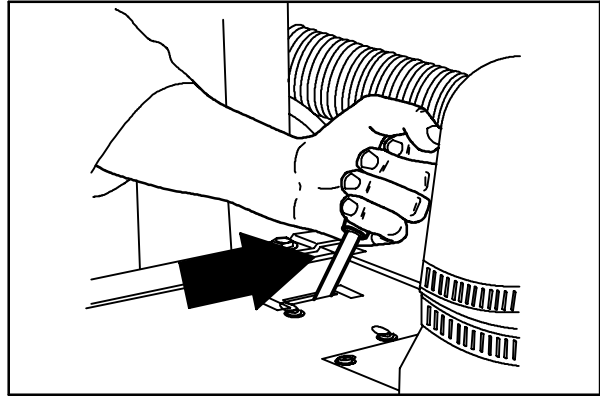

08145

5. Put the blower attachment on the back of the machine.

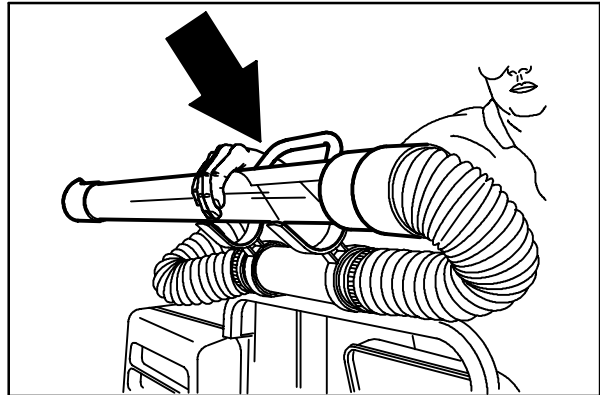

08145

HEATER VALVE

The *heater valve* is located in the engine compartment on the side of the engine. The valve controls the flow of hot coolant to the heater core.

The amount of coolant that flows through the *heater valve* is controlled with the *heater knob* in the cab (option).

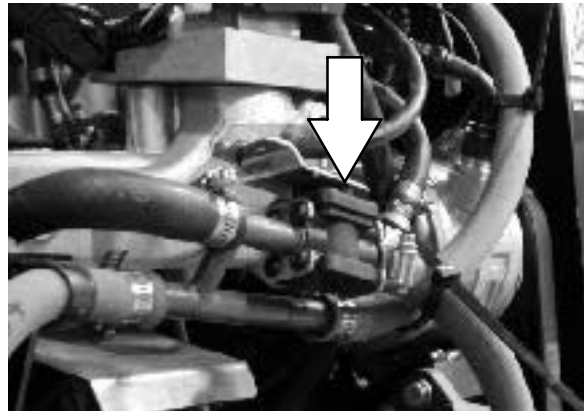

MACHINE TROUBLESHOOTING

Problem	Cause	Remedy
Excessive dusting	Brush skirts and dust seals worn, damaged, out of adjustment	Replace or adjust brush skirts or dust seals
	Hopper dust filter clogged	Shake and/or clean or replace dust filter
	Hopper dust filter not shaking clean	Connect shaker solenoid spring
		Install filter shaker plate correctly
		Insert shaker solenoid pin into the hole of filter element comb
	Engine operating at (Fast 2) speed	Operate engine at (Fast 1) speed
	Vacuum hose damaged	Replace vacuum hose
	Vacuum fan failure	Contact TENNANT service personnel
	Hopper door partially or completely closed	Open the hopper door
Thermo Sentry tripped	Reset Thermo Sentry	
Poor sweeping performance	Brush bristles worn	Replace brushes
	Main and side brushes not adjusted properly	Adjust main and side brushes
	Debris caught in main brush drive mechanism	Free drive mechanism of debris
	Main brush drive failure	Contact TENNANT service personnel
	Side brush drive failure	Contact TENNANT service personnel
	Hopper full	Empty hopper
	Hopper lip skirts worn or damaged	Replace lip skirts
	Hopper door partially or completely closed	Open the hopper door
	Wrong sweeping brush	Contact TENNANT representative for recommendations
	Main brush in Down position	Put main brush in Float position

MAINTENANCE

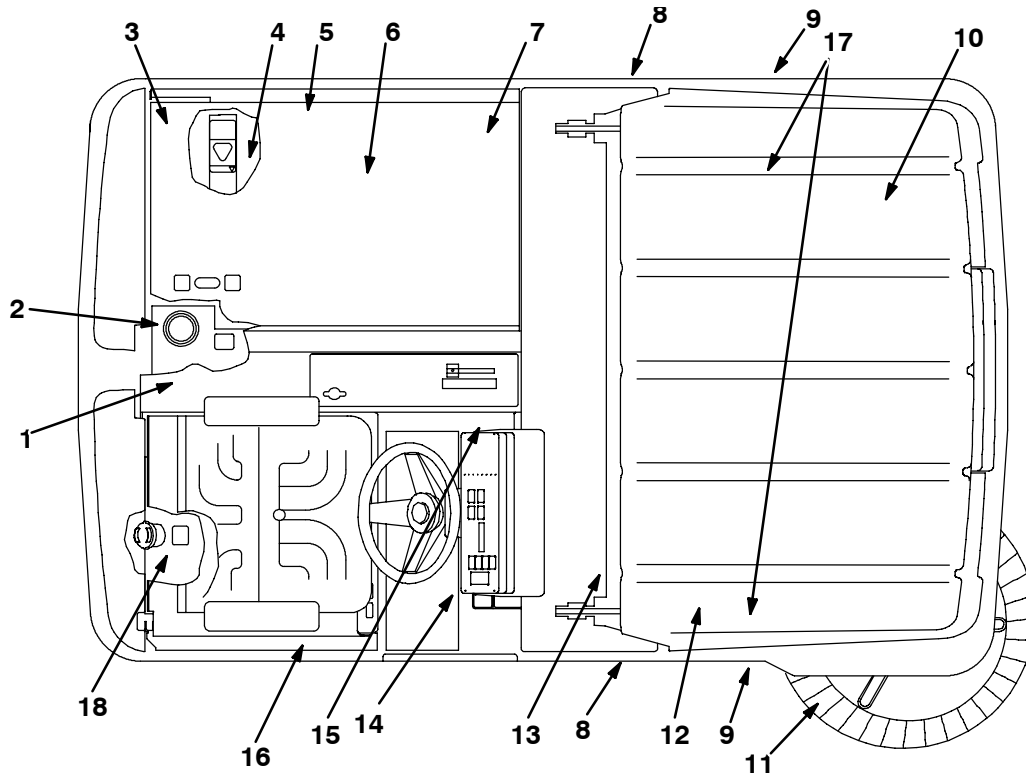

354038

MAINTENANCE CHART

NOTE: Check procedures indicated () after the first 50-hours of operation.*

Interval	Key	Description	Procedure	Lubricant/ Fluid	No. of Service Points
Daily	7	Engine air filter	Check indicator	-	1
			Empty dust cap	-	1
	6	Engine crankcase	Check oil level	EO	1
	8	Brush compartment skirts	Check for damage, wear and adjustment	-	5
	12	Hopper lip skirts	Check for damage, wear and adjustment	-	3
	12	Hopper side skirt	Check for damage and wear	-	1
	13	Main brush	Check for damage, wear, and adjustment	-	1
			Check brush pattern	-	1
	11	Side brush	Check for damage, wear, and adjustment	-	1
			Check brush pattern	-	1

Interval	Key	Description	Procedure	Lubricant/ Fluid	No. of Service Points
50 Hours	13	Main brush	Rotate end-for-end	-	1
	6	Fuel pipes and clamps	Check for tightness and wear	-	1
100 Hours	6	Engine crankcase	Change oil and filter	EO	1
	4	Engine fan belt	Check tension	-	1
	10	Hopper dust filter	Check for damage, clean or replace	-	1
	3	Radiator	Clean core exterior	-	1
			Check coolant level	WG	1
	2	Hydraulic fluid reservoir	Check fluid level	HYDO	1
	1	Rear tire	Check pressure	-	1
	8	Main brush and hopper seals	Check for damage or wear	-	8
200 Hours	3	Radiator hoses and clamps	Check for tightness and wear	-	2
	15	Parking brake	Check adjustment	-	1
	14	Brake pedal	Check and adjust travel	-	1
	1	Rear wheel support bearings	Lubricate	SPL	2
	17	Hopper bearings	Lubricate	SPL	2
	11	Side brush guard	Rotate 90°	-	1
400 Hours	9	Front wheel bearings	Check, lubricate, and adjust	SPL	2
	6	Fuel filter	Replace cartridge	-	1
	18	Fuel tank	Remove sediment	-	1
800 Hours	3	Cooling system	Flush	WG	1
	2	Hydraulic fluid reservoir	Replace hydraulic breather	-	1
			Replace suction strainer	-	1
			Change hydraulic fluid	HYDO	1
	5	Hydraulic fluid filter	Change filter element	-	1
	2	Hydraulic hoses	Check for wear and damage	-	31
	1	Propelling motor	*Torque shaft nut	-	1
	1	Rear wheel	*Torque wheel nuts	-	1
16	Battery	*Clean and tighten battery cable connections	-	1	

LUBRICANT/FLUID

EO Engine oil, diesel *rating* above CD grade only

HYDO . . . Tennant Company or approved hydraulic fluid

WG Water and permanent-type ethylene glycol anti-freeze, -34° C (-30° F)

SPL Special lubricant, Lubriplate EMB grease (TENNANT part no. 01433-1)

LUBRICATION

ENGINE

Check the engine oil level daily. Change the engine oil and oil filter every 100 hours of machine operation. Use engine oil with a diesel rating *above* CD grade only.

The following recommended oil grades are for use in engines during changing seasonal temperatures:

SINGLE AND MULTI-VISCOSITY OILS		
Below 32° F (Below 0° C)	32° to 77° F (0° to 25° C)	Above 77° F (Above 25° C)
10W	20	30
10W30	-	-

The low oil level is indicated by the mark closest to the end of the dipstick. Proper oil level is between the low and the full mark on top of the dipstick. The engine oil capacity is 6 L (6.35 qt) without the oil filter.



REAR WHEEL SUPPORT

The rear wheel support pivots the rear wheel. The support has two grease fittings for the bearings. The rear wheel support bearings must be lubricated every 200 hours of operation. Use Lubriplate EMB grease (TENNANT part no. 01433-1).

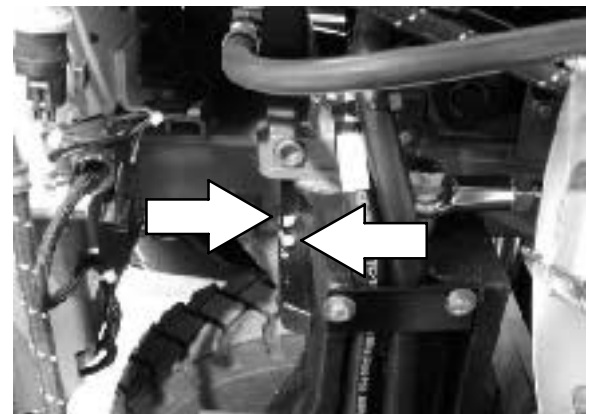

HOPPER BEARINGS

The hopper pivots on the hopper bearings whenever the hopper is raised or emptied. The hopper bearings must be lubricated after every 200 hours of operation. Use Lubriplate EMB grease (TENNANT part no. 01433-1).

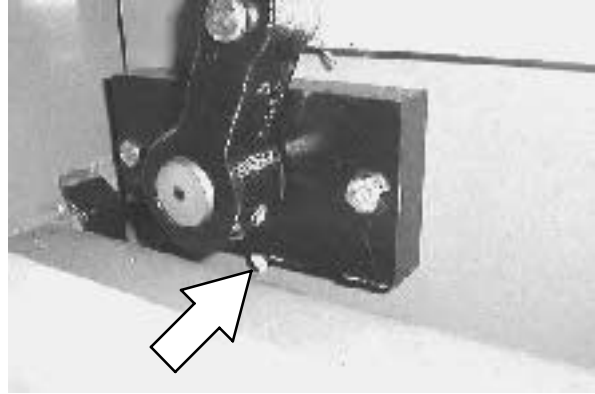
**FRONT WHEEL BEARINGS**

Inspect the front wheel bearings for seal damage, and repack and adjust every 400 hours of operation. Use Lubriplate EMB grease (TENNANT part no. 01433-1).



HYDRAULICS

HYDRAULIC FLUID RESERVOIR

The reservoir is located in the engine compartment next to the radiator.

Mounted on top of the reservoir is a filler cap with a fluid level dipstick. The reservoir also has a hydraulic breather located next to the filler cap. Replace the hydraulic breather after every 800 hours of operation.



Check the hydraulic fluid level at operating temperature every 100 hours of operation. Make sure the hopper is down when checking hydraulic fluid level. The end of the dipstick is marked with FULL and ADD levels to indicate the level of hydraulic fluid in the reservoir.



Lubricate the filler cap gasket with a film of hydraulic fluid before putting the cap back on the reservoir.

ATTENTION! Do not overfill the hydraulic fluid reservoir or operate the machine with a low level of hydraulic fluid in the reservoir. Damage to the machine hydraulic system may result.

Drain and refill the hydraulic fluid reservoir with new hydraulic fluid every 800 hours of operation.

The hydraulic fluid filter is located at the bottom of the engine compartment. Replace the filter element every 800 hours of operation.

The reservoir has a built-in strainer outlet that filters hydraulic fluid before it enters the system. Replace the strainer every 800 hours of operation.



HYDRAULIC FLUID

The quality and condition of the hydraulic fluid play a very important role in how well the machine operates. TENNANT's hydraulic fluid is specially selected to meet the needs of TENNANT machines.

TENNANT's hydraulic fluids provide a longer life for the hydraulic components. There are two fluids available for different temperature ranges:

TENNANT part no.	Ambient Temperature
65869	above 7° C (45° F)
65870	below 7° C (45° F)

The higher temperature fluid has a higher viscosity and should not be used at the lower temperatures. Damage to the hydraulic pumps may occur because of improper lubrication.

The lower temperature fluid is a thinner fluid for colder temperatures.

If a locally-available hydraulic fluid is used, make sure the specifications match TENNANT hydraulic fluid specifications. Using substitute fluids can cause premature failure of hydraulic components.

European manufactured machines are filled with locally available hydraulic fluids. Check the label on the hydraulic fluid reservoir.

ATTENTION! Hydraulic components depend on system hydraulic fluid for internal lubrication. Malfunctions, accelerated wear, and damage will result if dirt or other contaminants enter the hydraulic system.

HYDRAULIC HOSES

Check the hydraulic hoses every 800 hours of operation for wear or damage.

Fluid escaping at high pressure from a very small hole can be almost invisible, and can cause serious injuries.

See a doctor at once if injury results from escaping hydraulic fluid. Serious infection or reaction can develop if proper medical treatment is not given immediately.

FOR SAFETY: When servicing machine, use cardboard to locate leaking hydraulic fluid under pressure.

If you discover a fluid leak, contact your mechanic/supervisor.

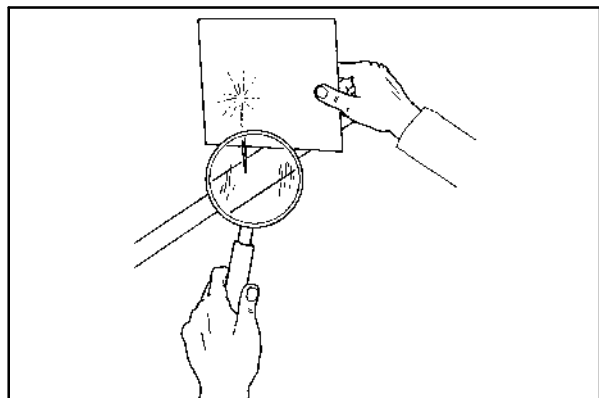

00002

PROPELLING MOTOR

Torque the shaft nut to 270 Nm (200 ft. lb) after the first 50-hours of operation, and every 800 hours there after.

ENGINE

COOLING SYSTEM

Check the radiator core exterior for debris every 100 hours of operation. Blow or rinse all dust, which may have collected on the radiator, in through the grille and radiator fins, opposite the direction of normal air flow. The grille and hydraulic cooler open for easier cleaning. Be careful not to bend the cooling fins when cleaning. Clean thoroughly to prevent the fins becoming encrusted with dust. Clean the radiator and cooler only after the radiator has cooled to avoid cracking.

FOR SAFETY: When servicing machine, wear eye and ear protection when using pressurized air or water.



Check the radiator coolant level every 100 hours of operation. Use clean water mixed with a permanent-type, ethylene glycol antifreeze to a -34°C (-30°F) rating.

FOR SAFETY: When servicing machine, avoid contact with hot engine coolant.

Check the radiator hoses and clamps every 200 hours of operation. Tighten the clamps if they are loose. Replace the hoses and clamps if the hoses are cracked, harden, or swollen.

Flush the radiator and the cooling system every 800 hours of operation, using a dependable cleaning compound.



AIR FILTER INDICATOR

The air filter indicator shows when to replace the air filter element. Check the indicator daily. The indicator's red line will move as the air filter element fills with dirt. Do not replace the air filter element until the red line reaches 5 kPa (20 in H₂O) and the "SERVICE WHEN RED" window is filled with red. The indicator's red line may return to a lower reading on the scale when the engine shuts off. The red line will return to a correct reading after the engine runs for a while.

Reset the air filter indicator by pushing the reset button on the end of the indicator after replacing the air filter element.

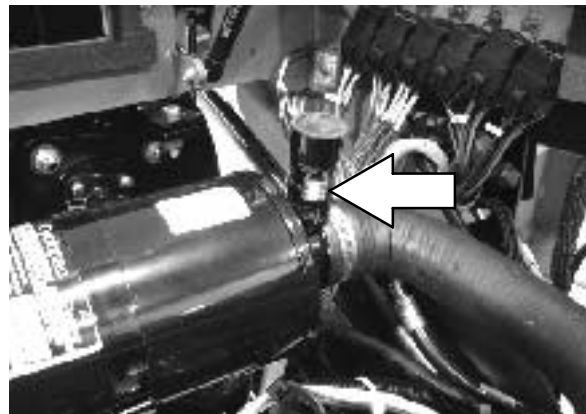

AIR FILTER

The engine air filter housing has a dust cap and a dry cartridge-type air filter element. Empty the dust cap daily. The air filter must be replaced whenever the filter element is damaged or when the air filter indicator shows a restriction. The air filters cannot be cleaned.

The machine is also equipped with a heavy duty air filter safety element. It is inside the standard element. Replace this element after the primary filter has been damaged or changed three times.



TO REPLACE AIR FILTER

1. Stop the engine and set the machine parking brake.

FOR SAFETY: Before leaving or servicing machine; stop on level surface, set parking brake, turn off machine and remove key.

2. Open the side door and engine cover.
3. Unlatch and gently remove the air cleaner dust cap. Empty the dust cap of any debris. Loosen the wingnut and remove the primary filter.



MAINTENANCE

4. Clean the inside walls of the filter housing with a clean cloth.
5. Replace the safety element after the primary filter has been changed three times.



6. Install the new primary filter and secure in place with the wingnut.

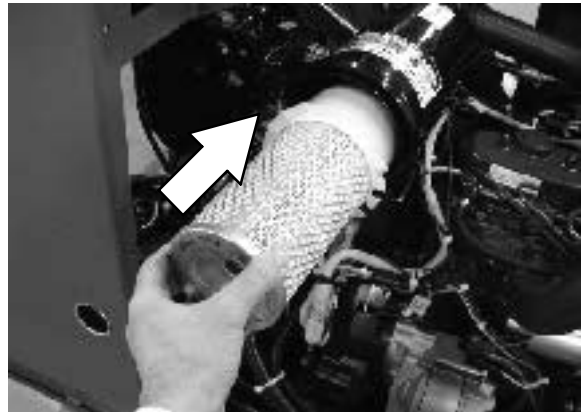

7. Install the dust cap on the air filter housing with the arrows pointing up.



8. Close the side door and engine cover.

FUEL FILTER

The fuel filter cartridge filters impurities from the fuel. It is located on the left side of the engine.

Replace the fuel filter element every 400 hours of operation.

FOR SAFETY: When servicing machine, keep flames and sparks away from fuel system service area. Keep area well ventilated.

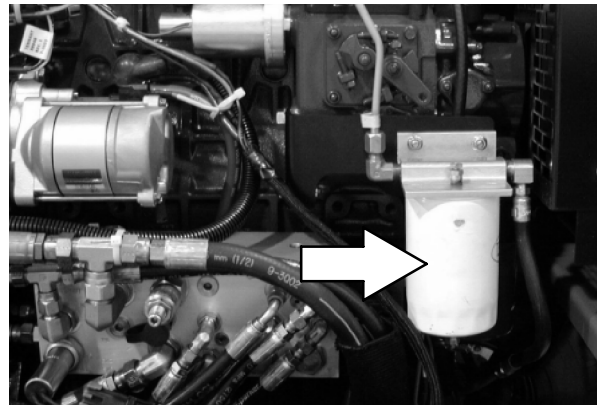

FUEL PIPES

Check the fuel pipes every 50 hours of operation. If the clamp band is loose, apply oil to the screw of the band, and securely tighten the band.

Made of rubber, the fuel pipes become worn out whether the engine has been used much or not. Replace the fuel pipes and clamp bands every two years.

If the fuel pipes and clamp bands are found worn or damaged before two years' time, replace or repair them at once. Bleed the fuel system after replacement of any of the fuel pipes, see *TO PRIME THE FUEL SYSTEM*. When the fuel pipes are not installed, plug both ends with clean cloth or paper to prevent dirt from entering the pipes. Dirt in the pipes can cause fuel injection pump malfunction.

PRIMING FUEL SYSTEM

Typical diesel fuel systems require priming to remove pockets of air in the fuel lines and fuel components. This is usually required after running out of fuel, changing fuel filter elements or repairing a fuel system component. Air in the fuel system prevents smooth engine operation.

This fuel system however is self-priming. The return line comes from the top of the injector which causes all air to escape through the return line.

MAINTENANCE

BATTERY

The battery for the machine is a low maintenance battery. Do not add water to the battery or remove the battery vent plugs.

After the first 50 hours of operation, and every 800 hours after that, clean and tighten the battery connections.

For Safety: When servicing machine, avoid contact with battery acid.



BELTS AND CHAINS

ENGINE FAN BELT

The engine fan belt is driven by the engine crankshaft pulley and drives the engine fan and alternator pulleys. Proper belt tension is obtained when the belt deflects 7 to 9 mm (0.28 to 0.35 in) from a force of 10 kg (22 lb) applied at the mid-point of the longest span.

Check and adjust the belt tension every 100 hours of operation.

 **WARNING: Moving belt and fan. Keep away.**

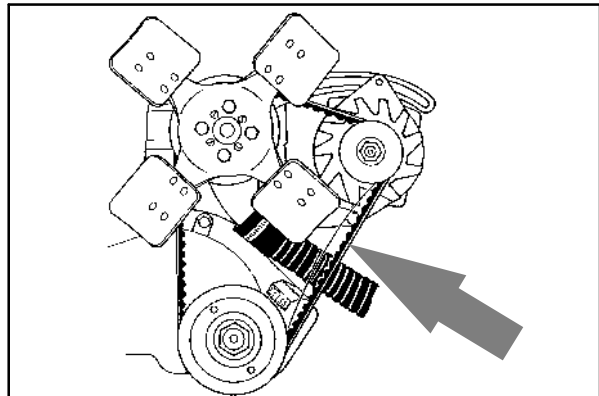

00577

STATIC DRAG CHAIN

A static drag chain prevents the buildup of static electricity in the machine. The chain is attached to the machine by a rear main brush skirt retaining bolt.

Make sure the chain is touching the floor at all times.



DEBRIS HOPPER

HOPPER DUST FILTER

The dust filter filters the air pulled up from the hopper. The dust filter is equipped with a shaker to remove the accumulated dust particles. The dust filter shaker is operated by the filter shaker switch.

The standard dust filter works very well for normal sweeping applications. The synthetic filter works well for humid or wet applications. The surface load filter works well for heavy fine dust applications. It keeps the dust on the outer surface of the filter, making filter shaking more effective.

Shake the dust filter before emptying the hopper and at the end of every work shift. Check and clean or replace the dust filter every 100 hours of operation.

To clean the dust filter, use one of the following methods:

- SHAKING - Press the filter shaker switch.
- TAPPING - Tap the filter gently on a flat surface with the dirty side down. Do not damage the edges of the filter element or the filter will not seat properly in the filter frame.
- AIR - Always wear eye protection when using compressed air. Blow air through the dust filter opposite the direction of the arrows. Never use more than 690kPa (100 psi) of air pressure and never closer than 50 mm (2 in) away from the filter. This may be done with the dust filter in the machine.

FOR SAFETY: When servicing machine, wear eye and ear protection when using pressurized air or water.

- WATER - Rinse the synthetic filter with a low pressure garden hose through the dust filter opposite the direction of the arrows. Both the standard and surface load dust filters can also be rinsed, but the filters will degrade with each rinsing and should be replaced after rinsing five times.

NOTE: Be sure the dust filter is dry before reinstalling it in the machine.



MAINTENANCE

TO REPLACE HOPPER DUST FILTER

1. Stop the engine and set the machine parking brake.

FOR SAFETY: Before leaving or servicing machine; stop on level surface, set parking brake, turn off machine and remove key.

2. Open the hopper cover.
3. Disconnect the filter shaker wire. For machines with the metal hopper, lift the dust filter cover for access to the wire.

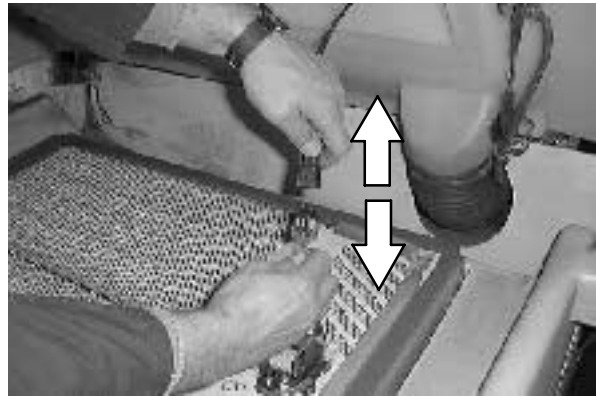

4. Lift the dust filter element assembly out from the hopper.



5. Cut the four cable ties that are holding the filter shaker plate to the element.

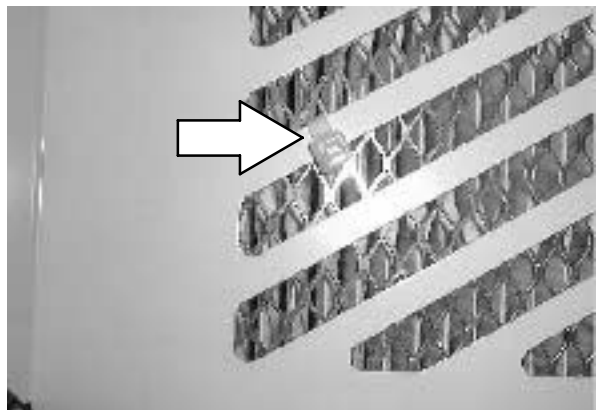

6. Remove the filter shaker plate from the dust filter element.
7. Clean or discard the dust filter element as required.

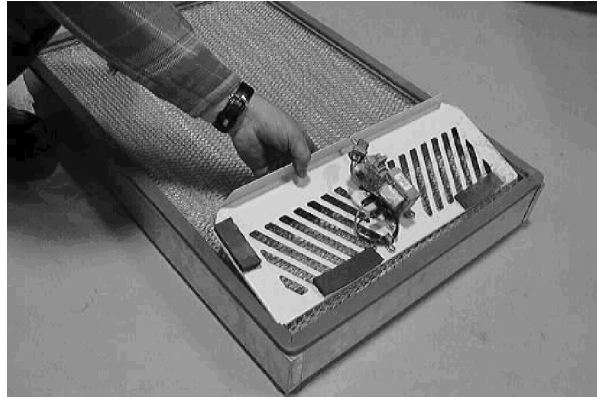

8. Remove the shipping tab from the dust filter element if a new element will be inserted into the machine.

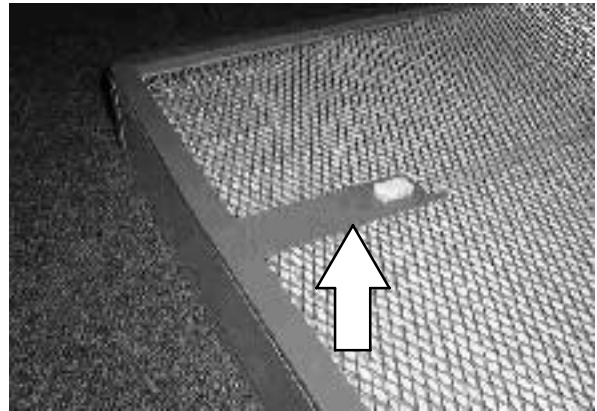

9. Place the filter shaker plate onto the new or cleaned dust filter element. Make sure the lip on the filter shaker plate is fastened over the lip on the dust filter element. Secure the filter shaker plate to the filter with four cable ties in the four corners of the filter shaker.



MAINTENANCE

10. Insert the pin from the shaker into the hole on the dust filter element comb.

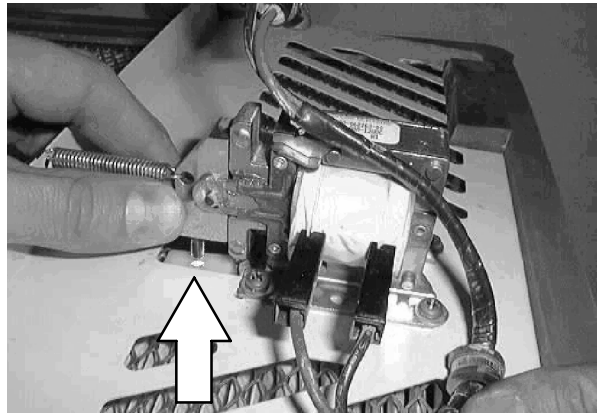

11. Check the shaker solenoid gap with the end of the shipping tab. The gap should be the same width as the tab. If it is not, loosen the mounting screws, adjust the gap by repositioning the shaker solenoid, then tighten the screws.



12. Place the dust filter element assembly into the hopper and reconnect the filter shaker wire. Fasten the assembly to the element with four new cable ties.

13. Close the hopper cover.

THERMO SENTRY

The Thermo Sentry senses the temperature of the air pulled up from the hopper. If there is a fire in the hopper, the Thermo Sentry stops the vacuum fan and cuts off the air flow.

Reset the Thermo Sentry by pushing in its reset button.

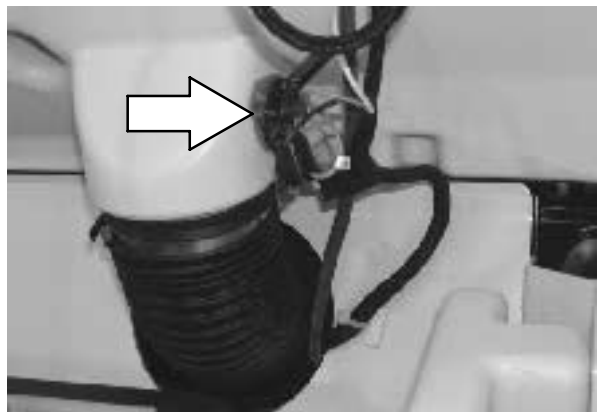

BRUSHES

MAIN BRUSH

The main brush is cylindrical and spans the width of the machine, sweeping debris into the hopper.

Check the brush daily for wear or damage. Remove any string or wire tangled on the main brush, main brush drive hub, or main brush idler hub.

Check the main brush pattern daily. The pattern should be 50 to 65 mm (2.0 to 2.5 in) wide with the main brush in the **Down** position.

Adjust the main brush pattern by setting the main brush adjustment plate.

Note the length of the main brush bristles with the color band on the brush idler plate before moving the main brush adjustment knob.

Align the pointer from the plate located under the knob, to match the same color band as the brush idler plate.

Rotate the main brush end-for-end every 50 hours of operation for maximum brush life and best sweeping performance.

Replace the main brush when the remaining bristles measure 50 mm (2.0 in) in length.

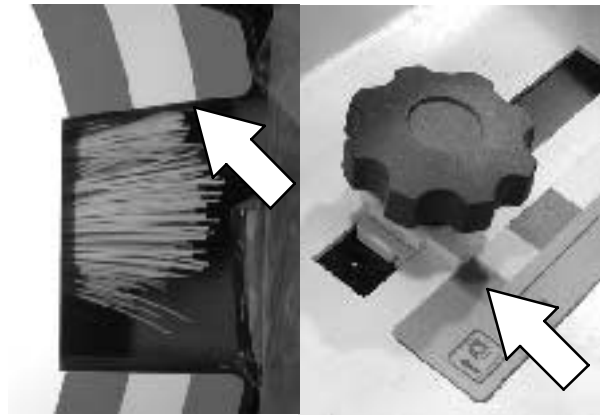

MAINTENANCE

TO REPLACE MAIN BRUSH

1. Stop the engine and set the machine parking brake.

FOR SAFETY: Before leaving or servicing machine; stop on level surface, set parking brake, turn off machine and remove key.

2. Raise the main brush.
3. Open the right side main brush access door.
4. Unlatch and remove the brush idler plate.

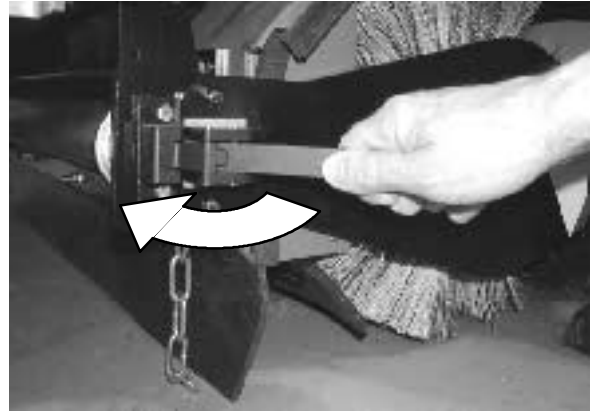

5. Grasp the main brush; pull it off the brush drive plug and out of the main brush compartment.
6. Put the new or rotated end-for-end main brush on the floor next to the access door.
7. Slide the main brush onto the drive plug. Rotate the brush until it engages the drive plug, and push it all the way onto the plug.



8. Replace the brush idler plate. Align the holes on the top and bottom of the brush idler plate latch with the pins on the machine frame. Secure the plate in position with the brush idler plate latch.
9. Close the right side main brush access door.

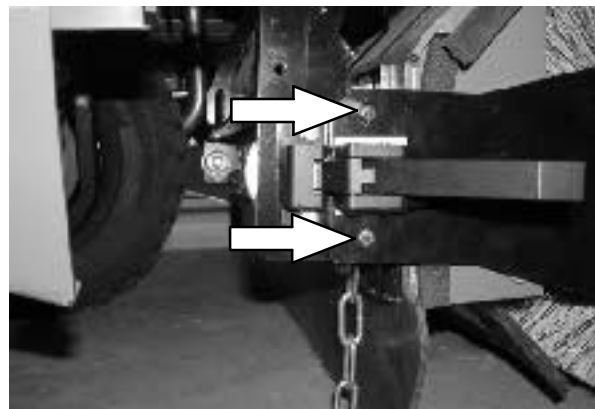

TO CHECK AND ADJUST MAIN BRUSH PATTERN

1. Apply chalk, or some other material that will not blow away easily, to a smooth, level floor.
2. Raise the side brush and main brush and position the main brush over the chalked area.
3. Start the main brush.
4. Lower the main brush for 15 to 20 seconds while keeping a foot on the brakes to keep the machine from moving. This will lower the rotating main brush.

NOTE: If chalk or other material is not available, allow the brushes to spin on the floor for two minutes. A polish mark will remain on the floor.

5. Raise the main brush.
6. Stop the main brush.
7. Drive the machine off the test area.
8. Observe the width of the brush pattern. The proper brush pattern width is 50 to 65 mm (2.0 to 2.5 in).

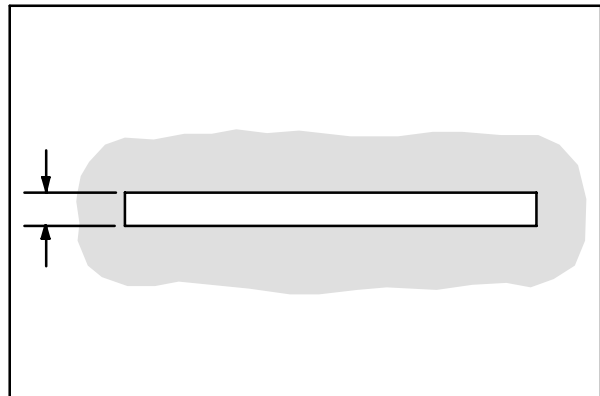

00582

9. To increase the width of the main brush pattern, loosen the main brush adjustment knob and slide the main brush adjustment plate forward 7 to 14 mm (0.25-0.50 in).

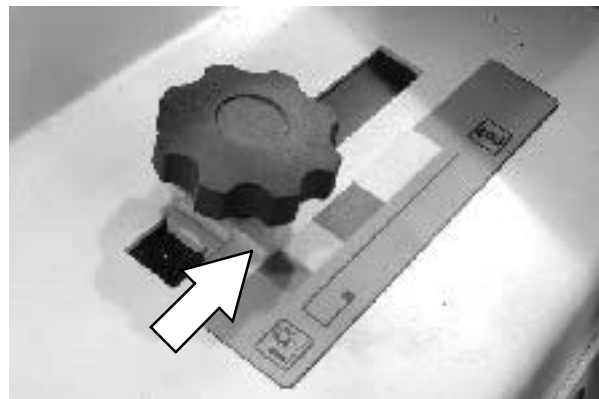

MAINTENANCE

To decrease the width of the main brush pattern, loosen the main brush adjustment knob and slide the main brush adjustment plate back 7 mm (0.25 in).

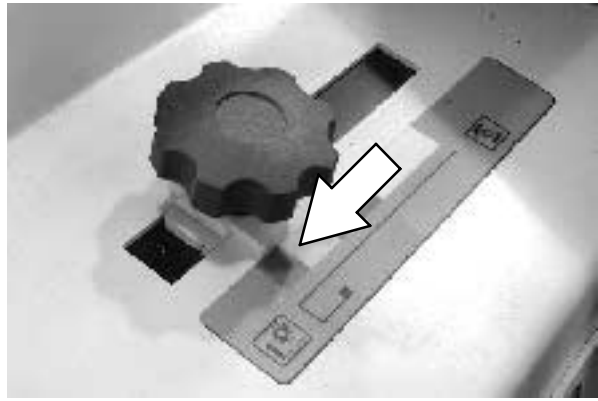

If the main brush pattern is tapered, more than 15 mm (0.5 in) on one end than the other, adjust the taper with the taper adjustment bracket at the drive end of the brush.

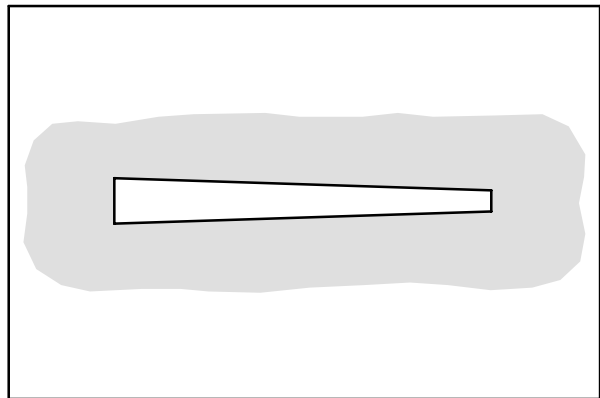

00601

A. Loosen the shaft bearing bracket mounting bolts.

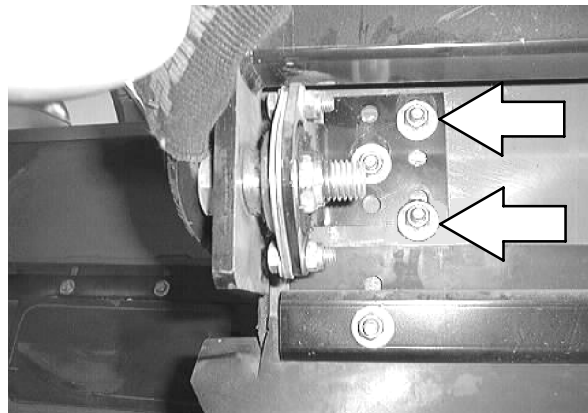

B. Move the bracket up or down in the slots and tighten the mounting bolts.

C. Check the main brush pattern and readjust as necessary. Set the main brush adjustment knob to match the same color band as the brush idler plate.

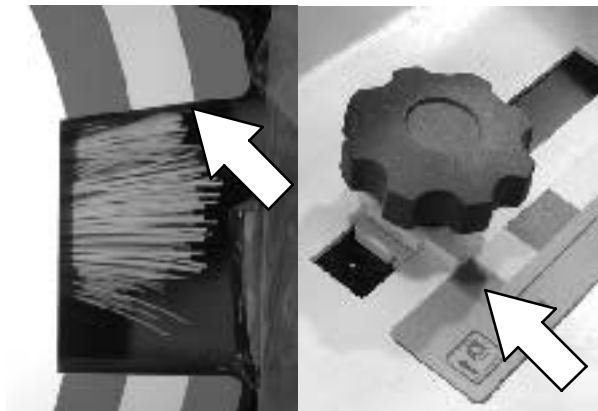

SIDE BRUSH

The side brush sweeps debris along edges into the path of the main brush.

Check the brush daily for wear or damage. Remove any string or wire found tangled on the side brush or side brush drive hub.

Check the side brush pattern daily. The side brush bristles should contact the floor in a 10 o'clock to 3 o'clock pattern when the brush is in motion.

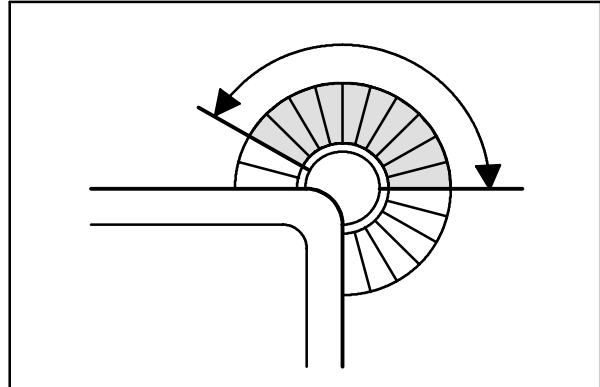

350327

Adjust the side brush pattern by the side brush down pressure knob. It is located under the right side of the hopper cover. Pull on the lever to release tension on the side brush cable, then turn the knob counter-clockwise to increase the brush contact with the sweeping surface, and clockwise to decrease the brush contact with the sweeping surface. Release the lever when finished.

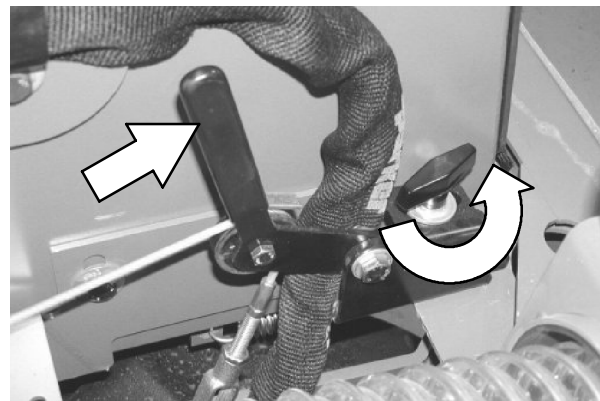

The side brush should be replaced when it no longer sweeps effectively for your application. A guideline length is when the remaining bristles measure 50 mm (2 in) in length. You may change the side brush sooner if you are sweeping light litter, or wear the bristles shorter if you are sweeping heavy debris.

MAINTENANCE

TO REPLACE SIDE BRUSH

1. Empty the debris hopper.
2. Set the machine parking brake.
3. Stop the engine.

FOR SAFETY: Before leaving or servicing machine; stop on level surface, set parking brake, turn off machine and remove key.

4. Raise the side brush.
5. Remove the side brush retaining pin from the side brush drive shaft by pulling the pin keeper off over the end of the pin.
6. Slide the side brush off the side brush drive shaft.

NOTE: Remove the drive hub and put it on the new brush if one is not installed.

7. Slide the new side brush onto the side brush drive shaft.
8. Insert the side brush retaining pin through the side brush hub and shaft.
9. Secure the pin by clipping the pin keeper over the end of the pin.
10. Disengage the hopper support bar and lower the hopper.
11. Adjust the side brush pattern with the side brush down pressure knob.

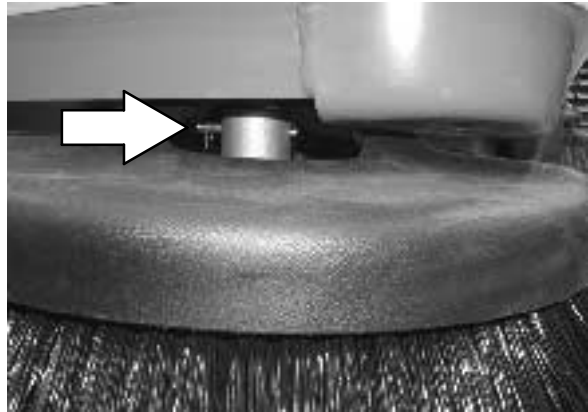

SIDE BRUSH GUARD

Rotate the side brush guard 90° every 200 hours of operation. Replace the brush guard after all four sides have been used.



SKIRTS AND SEALS

HOPPER LIP SKIRTS

The hopper lip skirts are located on the bottom rear of the hopper. The skirts float over debris and help deflect that debris into the hopper. The hopper lip skirts consist of five bottom lip segments and two additional side lip segments.

Check the hopper lip skirts for wear or damage daily.

Replace the hopper lip skirts when they no longer touch the floor.



HOPPER SIDE SKIRT

The hopper side skirt is located on the left side of the hopper.

Check the hopper side skirt for wear or damage daily.

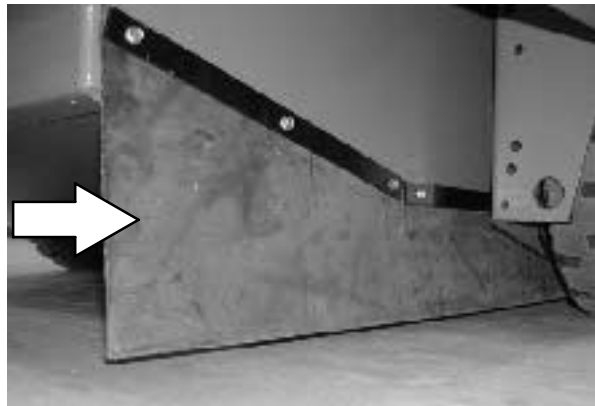

BRUSH DOOR SKIRTS

The brush door skirts are located on the bottom of each of the two main brush doors. The skirts should clear the floor by 3 to 6 mm (0.12 to 0.25 in).

Check the skirts for wear or damage and adjustment daily.

NOTE: The brush door skirts have slotted holes to allow for a ground clearance adjustment. The door must be closed for proper adjustment.

NOTE: Rear tire pressure will affect skirt clearances.



MAINTENANCE

REAR SKIRTS

The two rear skirts are located on the bottom rear of the main brush compartment. The vertical skirt should clear the floor up to 5 mm (0.25 in) in dusty conditions, and touch the floor otherwise. The recirculation skirt is self-adjusting.

Check the skirts for wear or damage and adjustment daily.

NOTE: Rear tire pressure will affect skirt clearances.

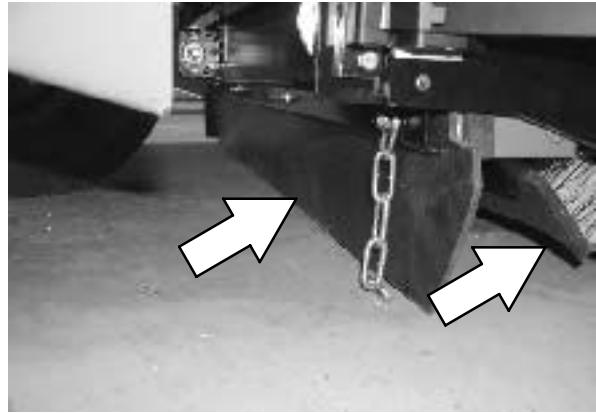

SIDE BRUSH DUST CONTROL SKIRTS (OPTION)

The side brush dust control skirts wrap around the side brush and the bottom of the hopper.

Check the side brush dust control skirts for wear or damage daily.

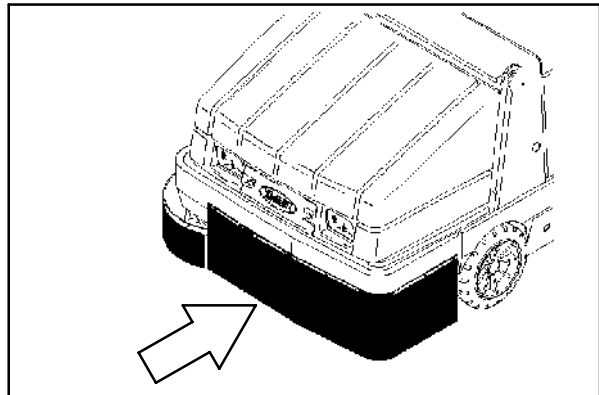

BRUSH DOOR SEALS

The brush door seals are located on both main brush doors and on corresponding portions of the main frame.

Check the seals for wear or damage every 100 hours of operation.



HOPPER SEALS

The hopper seals are located on the front and side portions of the machine frame that contact the hopper.

Check the seals for wear or damage every 100 hours of operation.

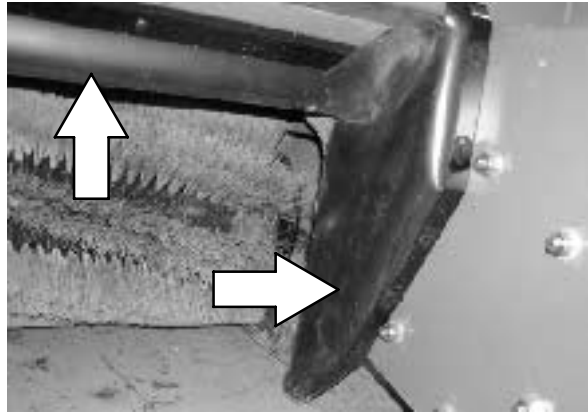
**HOPPER DOOR SEALS**

The hopper door seals are located on the hopper door. They seal the hopper when the hopper door is closed.



Check the seals for wear or damage every 100 hours of operation.

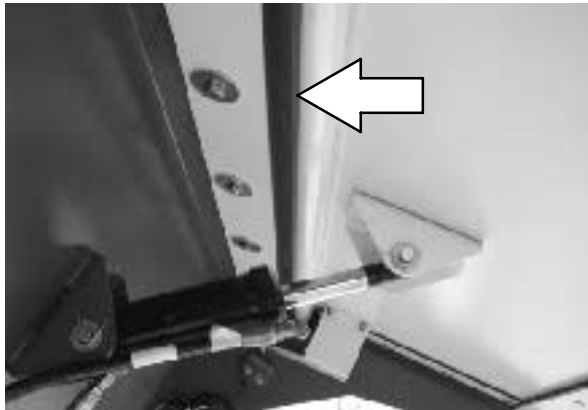

MAINTENANCE

HOPPER FILTER SEALS

The hopper filter seals are mounted on the hopper directly below the filter. They are also mounted on both sides of the hopper dust filter element and on the edges of the filter shaker.

Check the seals for wear or damage after every 100 hours of operation. You can reach the seals by lifting the dust filter cover and removing the filter element.

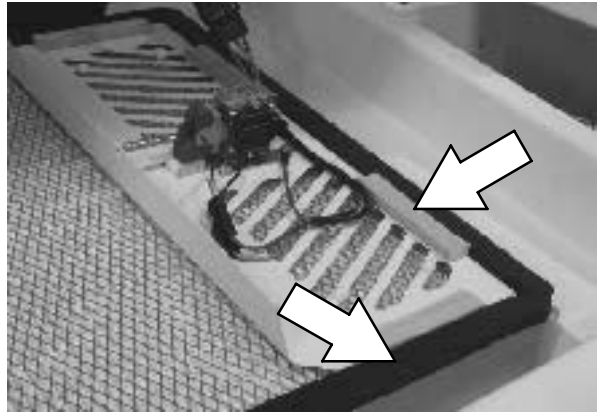

HOPPER INSPECTION DOOR SEAL

The hopper inspection door seal is located on the hopper and seals the front of the debris hopper.

Check the seal for wear or damage every 100 hours of operation.

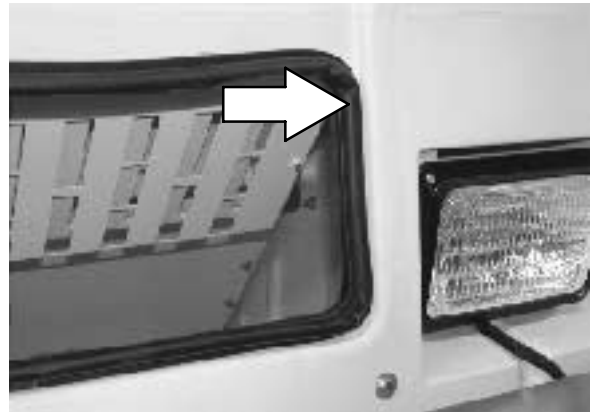

VACUUM WAND DOOR SEALS (OPTION)

The vacuum wand door seal is located on the back side of the vacuum wand door (option). It seals the vacuum wand opening when the vacuum wand (option) is not in use.

Check the seal for wear or damage every 100 hours of operation.

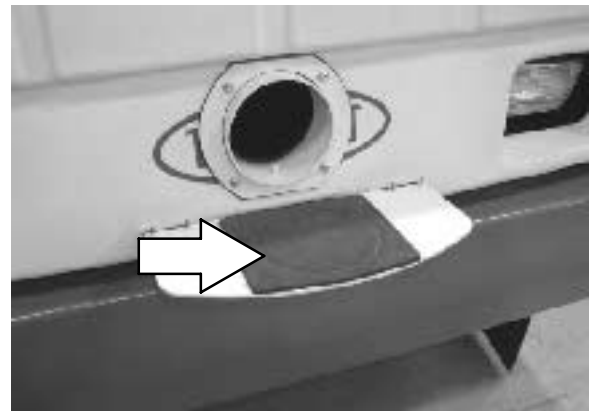

BRAKES AND TIRES

SERVICE BRAKES

The mechanical service brakes are located on the front wheels. The brakes are operated by the foot brake pedal and connecting cables.

Check the brake adjustment every 200 hours of operation. The brake pedal should not travel more than 25 mm (1 in) to fully engage the brakes.

PARKING BRAKE

The parking brake is set with the parking brake lever that activates the service brakes.

Adjust the parking brake whenever it becomes very easy to set the parking brake, when the machine rolls after setting the parking brake, and every 200 hours of operation. The parking brake may be tightened by turning the knurled knob on the end of the parking brake clockwise.



TIRES

The standard front machine tires are solid. The standard rear machine tire is pneumatic.

Check the rear tire pressure every 100 hours of operation. The proper tire air pressure is 790 ± 35 kPa (115 ± 5 psi).



REAR WHEEL

Torque the rear wheel nuts in a star pattern twice to 142 to 157 Nm (105 to 115 ft. lb) after the first 50-hours of operation, and every 800 hours there after.

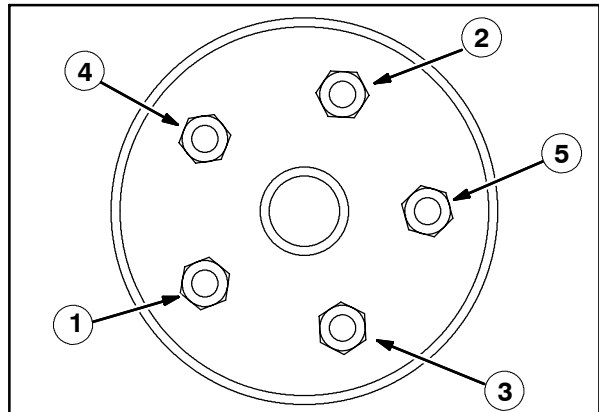

PUSHING, TOWING, AND TRANSPORTING THE MACHINE

PUSHING OR TOWING THE MACHINE

If the machine becomes disabled, it can be pushed from the front or rear, but towed only from the rear.

The propelling pump has a bypass valve to prevent damage to the hydraulic system when the machine is being pushed or towed. This valve allows a disabled machine to be moved for a *very short distance* and at a speed to not exceed 1.6 kph (1 mph). The machine is NOT intended to be pushed or towed a long distance or at a high speed.

ATTENTION! Do not push or tow machine for a long distance and without using the bypass valve, or the machine hydraulic system may be damaged.

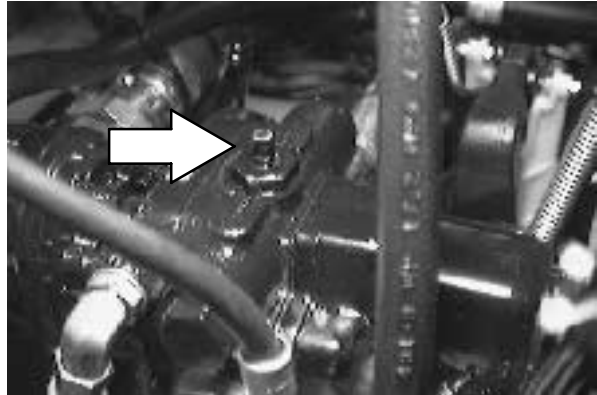

Turn the bypass valve 90° from the normal position before pushing or towing the machine. **The illustration shows the bypass valve in the pushing or towing position.**

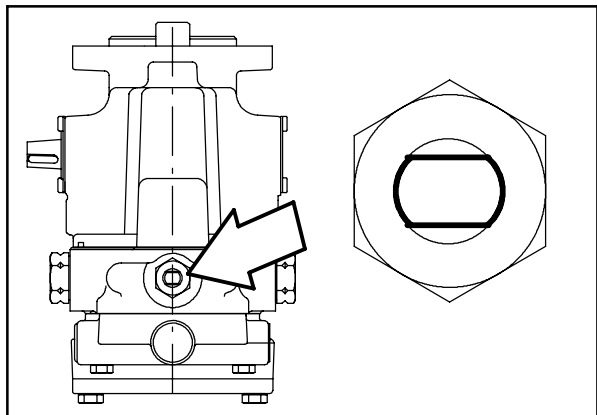

TRANSPORTING THE MACHINE

1. Position the rear of the machine at the loading edge of the truck or trailer.

FOR SAFETY: Use truck or trailer that will support the weight of the machine.

NOTE: Empty the hopper before transporting the machine.

2. If the loading surface is not horizontal or is higher than 380 mm (15 in) from the ground, use a winch to load machine.

If the loading surface is horizontal AND is 380 mm (15 in) or less from the ground, the machine may be driven onto the truck or trailer.

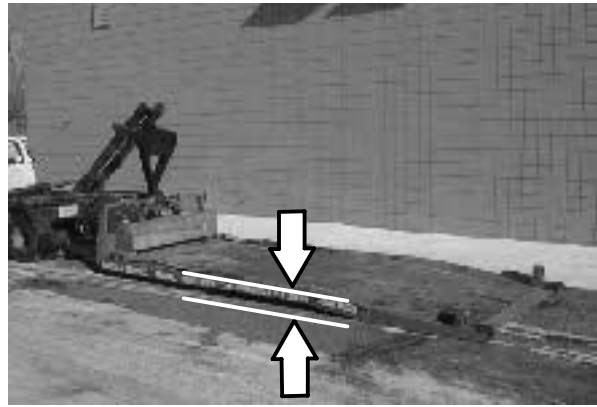

3. To winch the machine onto the truck or trailer, attach the winching chains in the holes at the bottom of the rear bumper.

If the machine has the optional rear tie down brackets, attach the winching chains to them.

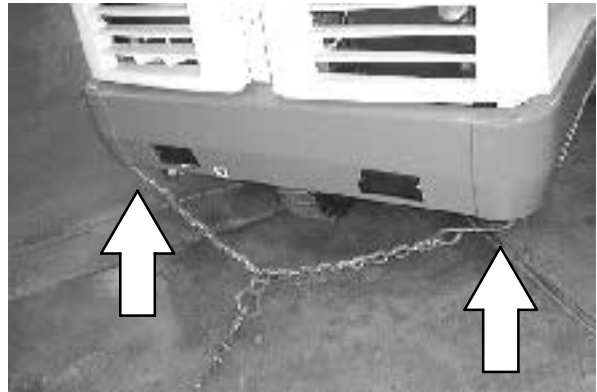

4. Turn the bypass valve 90° from the normal position before winching the machine onto the truck or trailer. See *PUSHING OR TOWING THE MACHINE* section of this manual. Make sure the machine is centered.

FOR SAFETY: When loading machine onto truck or trailer, use winch. Do not drive the machine onto the truck or trailer unless the loading surface is horizontal AND is 380 mm (15 in) or less from the ground.

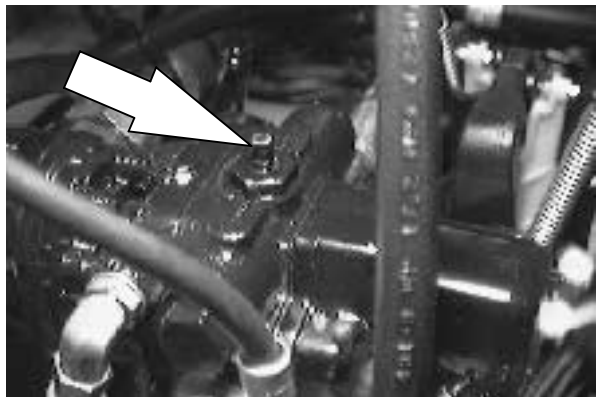

MAINTENANCE

5. Position the machine onto the truck or trailer as far as possible. If the machine starts to veer off the centerline of the truck or trailer, stop and turn the steering wheel to center the machine.
6. Set the parking brake and block the machine tires. Tie down the machine to the truck or trailer before transporting.

The front tie down locations are the holes in the wheel pockets at the front of the machine frame.

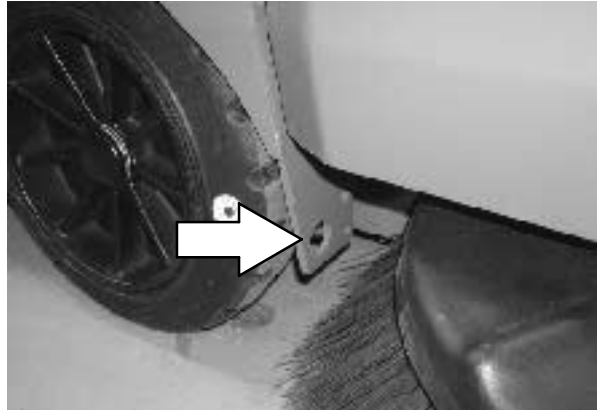

If the machine has the optional front tie down brackets above the front tires, attach the winching chains to them.

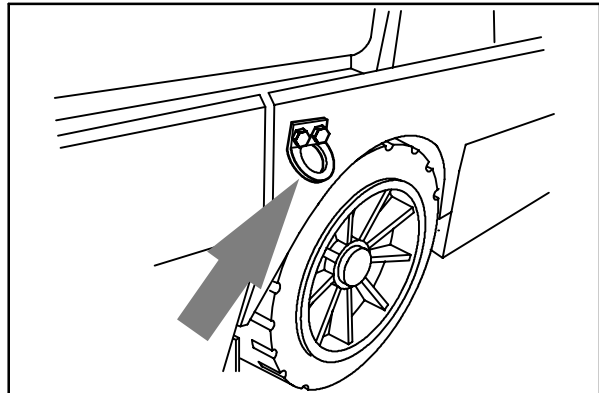

08152

The rear tie down locations are in the holes at the bottom of the rear bumper. If the machine has the optional rear tie down brackets, use them to tie down the machine.

7. If the loading surface is not horizontal or is higher than 380 mm (15 in) from the ground, use a winch to unload machine.

If the loading surface is horizontal AND is 380 mm (15 in) or less from the ground, the machine may be driven off the truck or trailer.

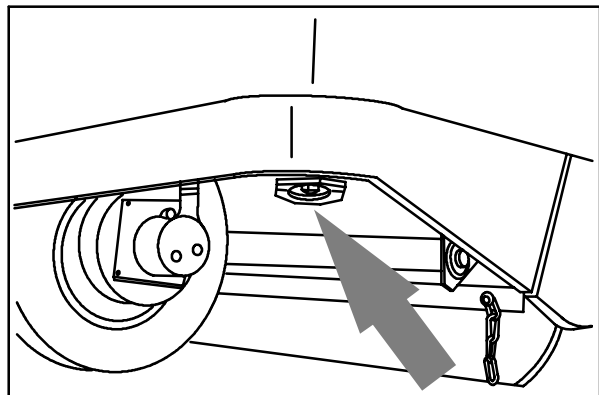

08151

FOR SAFETY: When unloading machine off truck or trailer, use winch. Do not drive the machine off the truck or trailer unless the loading surface is horizontal AND 380 mm (15 in) or less from the ground.

MACHINE JACKING

Empty the hopper before jacking the machine. You can jack up the machine for service at the designated locations. Use a hoist or jack that will support the weight of the machine. Always stop the machine on a flat, level surface and block the tires before jacking the machine up.

The front jacking locations are on the flat bottom edge of the front of the machine frame next to the front tires.

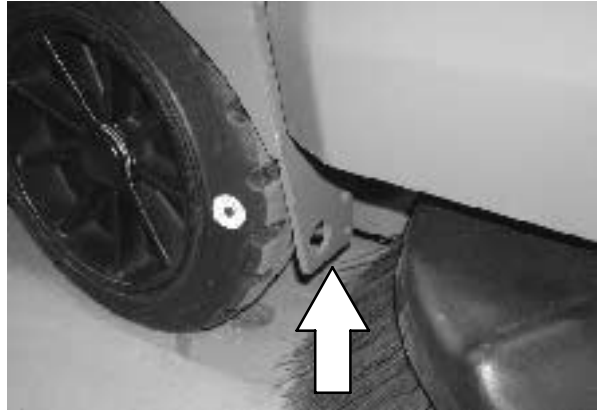

The rear jacking location is the middle flat bottom edge of the rear bumper between the taillights.

FOR SAFETY: When servicing machine, block machine tires before jacking machine up.

FOR SAFETY: When servicing machine, jack machine up at designated locations only. Block machine up with jack stands.

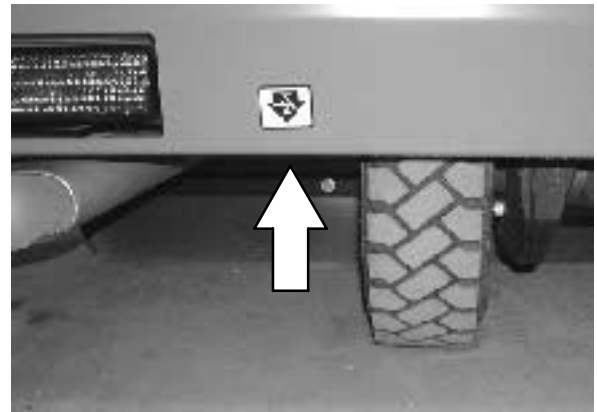

STORING MACHINE

Before storing the machine for an extended period of time, the machine needs to be prepped to lessen the chance of rust, sludge, and other undesirable deposits from forming. Contact TENNANT service personnel.

SPECIFICATIONS

SPECIFICATIONS

GENERAL MACHINE DIMENSIONS/CAPACITIES

Item	Dimension/capacity
Length	2360 mm (93 in)
Width	1585 mm (62.5 in)
Height	1470 mm (58 in)
Height with overhead guard	2080 mm (82 in)
Height with overhead guard and hazard light	2270 mm (89.5 in)
Height with cab	2100 mm (82.62 in)
Height with cab and hazard light	2285 mm (90 in)
Track	1345 mm (53 in)
Wheelbase	1135 mm (44.75 in)
Main brush diameter	355 mm (14 in)
Main brush length	1145 mm (45 in)
Side brush diameter	660 mm (26 in)
Sweeping path width	1145 mm (45 in)
Sweeping path width with side brush	1560 mm (61.5 in)
Main brush pattern width	50 to 65 mm (2.0 to 2.5 in)
Hopper weight capacity	409 kg (900 lb)
Hopper volume capacity	396 L (14 cu ft)
Dust filter area	7 m ² (77.6 sq ft)
GVWR	1927 kg (4250 lb)
Sound level	80 dBa
Ceiling height minimum dumping clearance	2745 mm (9 ft)

GENERAL MACHINE PERFORMANCE

Item	Measure
Maximum forward speed	16.1 kmh (10 mph)
Maximum reverse speed	4.0 kmh (2.5 mph)
Minimum aisle turn width, left	2870 mm (113 in)
Minimum aisle turn width, right	4725 mm (186 in)
Maximum rated climb and descent angle	10° (Full Hopper), 15° (Empty Hopper)

TIRES

Location	Type	Size	Pressure
Front (2)	Solid	5 x 18 in	-
Rear (1)	Pneumatic	4.5 x 18 in	790 ± 35 kPa (115 ± 5 psi)

POWER TYPE

Engine	Type	Ignition	Cycle	Aspiration	Cylinders	Bore	Stroke
Kubota V1505-B	Piston	Diesel	4	Natural	4	78 mm (3.07 in)	78.4 mm (3.08 in)
	Displacement		Net power, governed			Net power, maximum	
	1500 cc (91.4 cu in)		24.6 kw (34 hp) @ 2400 rpm			27.2 kw (37.5 hp) @ 3000 rpm	
	Fuel		Cooling system			Electrical system	
	Diesel Fuel tank: 36 L (9.6 gal)		Water/ethylene glycol antifreeze			12 V nominal	
			Total: 4.5 L (1.2 gal)			50 A alternator	
			Radiator: 3.8 L (1 gal)				
	Idle speed, no load		(Fast 1) governed speed, under load			(Fast 2) governed speed, under load	
	1350 ± 50 rpm		2000 ± 50 rpm			2400 ± 50 rpm	
	Engine lubricating oil without filter						
6 L (6.35 qt) diesel rated engine oil <i>above</i> CD grade only							

STEERING

Type	Power source	Emergency steering
Rear wheel, hydraulic cylinder and rotary valve controlled	Hydraulic accessory pump	Manual

HYDRAULIC SYSTEM

System	Capacity	Fluid Type
Hydraulic reservoir	24.6 L (6.5 gal)	TENNANT part no. 65869 - above 7° C (45° F)
Hydraulic total	N/A L (N/A gal)	TENNANT part no. 65870 - below 7° C (45° F)

BRAKING SYSTEM

Type	Operation
Service brakes	Mechanical drum brakes (2), one per front wheel, cable actuated
Parking brake	Utilize service brakes, cable actuated

SPECIFICATIONS

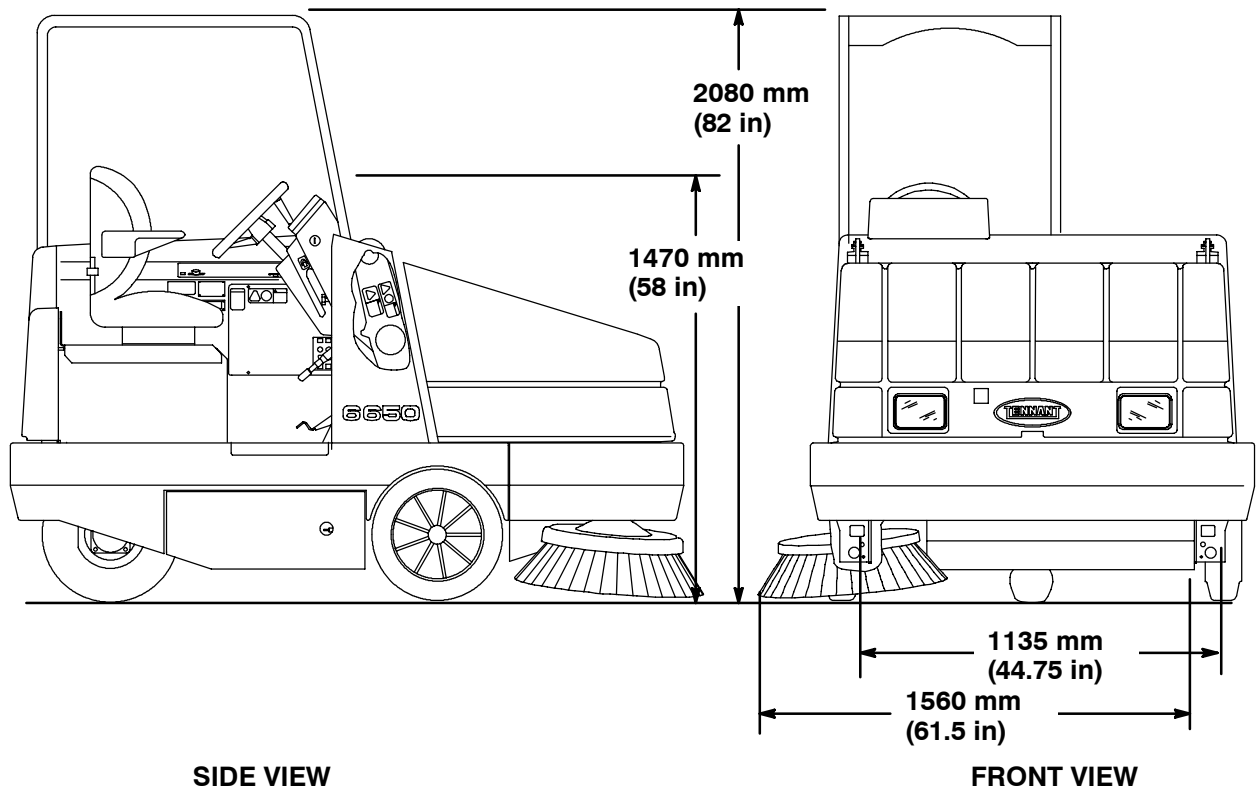
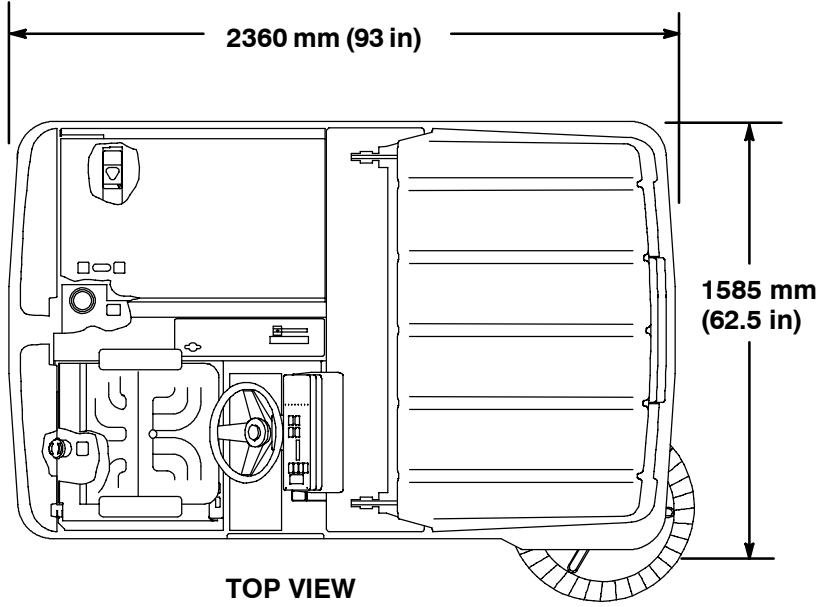

MACHINE DIMENSIONS

354038

A

Adjustment, Deluxe suspension seat, 29
 Air conditioning switch (option), 31
 Air filter, 61
 Dust cap, 61
 Element, 61
 Heavy duty filter option, 61
 Air filter indicator, 61
 Aisle turn, 84
 Alternator light, 23

B

Battery, 64
 Bearings
 Front wheel, 57
 Hopper, 57
 Belts, 64
 Engine fan belt, 64
 Blower wand, 51–52
 Brake pedal, 13
 Brakes, 33, 42, 79
 Parking, Adjustment, 79
 Service, 79
 System specifications, 85
 Brushes, 36–37, 69–73
 Adjusting main brush taper, 72–74
 Checking main brush pattern, 71–73
 Checking side brush pattern, 73
 Door latch, 28
 Door seals, 76
 Door skirts, 75
 Main brush, 69–72
 Main brush bristle length, 69
 Maintenance, 33, 42
 Pattern adjustment, 33, 42
 Replacing main brush, 70–71
 Replacing side brush, 74
 Side brush, 73–74
 Side brush bristle length, 73
 Button, Horn, 18
 Bypass valve, 80

C

Cab
 Air conditioning switch, 31
 Dome light switch, 32
 Door latch, 28
 Heater knob (option), 31
 Pressurizer switch, 32
 Windshield wiper switch, 31

Capacities, 84
 Chains, 64
 Static drag, 64
 Circuit breakers, 27
 Clogged dust filter light, 22
 Control panel
 Alternator light, 23
 Glow Plug light, 23
 Low fuel light, 22
 Operating/hazard lights switch, 25
 Thermo Sentry light, 22
 Controls
 Air conditioning switch (option), 31
 Alternator light, 23
 Brake pedal, 13
 Circuit breakers, 27
 Clogged dust filter light, 22
 Directional pedal, 12
 Dome light switch, 32
 Engine speed control switch, 16
 Fuel gauge, 17
 Fuses, 26
 Glow Plug light, 23
 Heater knob (option), 31
 High engine temperature light, 21
 Hopper close switch, 17
 Hopper down, 18
 Hopper open switch, 17
 Hopper up switch, 18
 Horn button, 18
 Hourmeter, 16
 Ignition switch, 24
 Latches, 28
 LCD Window, 16
 Low engine oil pressure light, 21
 Low fuel light, 22
 Main broom stalled light, 21
 Main brush adjustment knob, 19
 One Step switch, 14
 Operating/hazard lights switch, 25
 Operation, 12–30
 Parking brake lever, 13
 Pressurizer switch, 32
 Shake filter switch, 15
 Side brush down pressure knob, 25
 Side brush switch, 15
 Steering column tilt lever, 23
 Steering wheel, 23
 Symbols, 9–10
 Thermo Sentry light, 22
 Turn signal switch, 20
 Vacuum fan switch, 15
 Windshield wiper switch, 31

Controls and Instruments, 11–29

Covers

- Engine, Latch, 28
- Hopper, Latch, 28

D

Debris Hopper, Thermo Sentry, Light, 22

Debris hopper, 65–67

- Dust filter and seals, 33

Debris hopper , clogged filter, Light, 22

Deluxe suspension seat, 29

Dimensions, 84

Directional pedal, 12

Disengaging hopper support bar, 45–46

Dome light switch, 32

Doors

Brush

- Latch, 28
- Seals, 76
- Skirts, 75

Cab, Latch, 28

Engine side, Latch, 28

Grille, Latch, 28

Hopper, Seals, 77

Hopper Inspection, Seal, 78

Right rear Grille, Latch, 28

Vacuum wand , Seal, 78

Dust Control, Skirts, 76

Dust filter, 65–67

- Changing, 61–62, 66–67
- Cleaning, 65

E

Electrical

- Circuit breakers, 27
- Fuses, 26
- Ignition switch, 24

Emptying the hopper, 39–40

Engaging hopper support bar, 43–44

Engine, 60–62

- Air filter, 61
- Air filter indicator, 61
- Alternator, Light, 23
- Coolant level, 33
- Coolant temperature, Light, 21
- Cooling system, 60
- Cover latch, 28
- Fan belt, 64
- Fuel filter, 63
- Fuel level, 33, 42

Fuel pipes, 63

Low engine oil pressure, Light, 21

Low fuel, Light, 22

Lubrication, 56

Oil capacity, 56

Oil level, 7, 33, 42

Priming fuel system, 63

Service records, 33

Side door latch, 28

Specifications, 85

Engine speed control switch, 16

F

Fuel filter, 63

Fuel gauge, 17

Fuel pipes, 63

Fuel system

- Fuel pipes, 63
- Priming, 63

Fuel tank, 7

Fuses, 26

G

Gauges, Fuel, 17

Glow Plug light, 23

Grease fittings

- Hopper bearings, 57
- Rear wheel support, 56

H

Heater knob (option), 31

Heater valve, 52

High engine temperature light, 21

Hopper, 65–67

- Changing dust filter, 61–62, 66–67
- Cover latch, 28
- Disengaging hopper support bar, 45–46
- Door seals, 77
- Dust filter, 65–67
- Engaging hopper support bar, 43–44
- Filter cleaning, 65
- Inspection door seal, 78
- Lip skirts, 75
- Seals, 77
- Side skirt, 75
- Support bar, 29
- Thermo-Sentry, 68
- Filter seals, 78
- Vacuum wand door seal, 78

Hopper close switch, 17
 Hopper down switch, 18
 Hopper open switch, 17
 Hopper support bar, 29
 Hopper up switch, 18
 Horn button, 18
 Hourmeter, 16
 How the machine works, 33
 Hydraulic cooler, Fins, 33, 42
 Hydraulic fluid, 58–59
 Hydraulic fluid reservoir, 58
 Hydraulic hoses, 59
 Hydraulics, 58–59
 Fluid, 58–59
 Fluid filter, 58
 Fluid level, 7, 33, 42, 58
 Hoses, 59
 Propelling motor, 59
 Reservoir, 58
 System specifications, 85

I

Ignition switch, 24

J

Jack points, 83–84

K

Knobs
 Heater (option), 31
 Side brush down pressure, 25

L

Latches, 28
 Cab door, 28
 Engine cover, 28
 Engine side door, 28
 Grille doors, 28
 Right rear, 28
 Hopper cover, 28
 Hydraulic cooler, 28
 Main brush doors, 28
 LCD Window, 16

Levers
 Parking brake, 13
 Steering column tilt, 23

Lights
 Alternator, 23
 Clogged dust filter light, 22
 Glow Plug, 23
 High engine temperature, 21
 Low engine oil pressure, 21
 Low fuel, 22
 Main broom stalled, 21
 Operating/hazard lights switch, 25
 Thermo Sentry, 22

Low engine oil pressure light, 21

Low fuel light, 22

Lubrication, 56
 Engine, 56
 Front wheel bearings, 57
 Hopper bearings, 57
 Rear wheel support, 56

M

Machine components, 8
 Machine dimensions, 86
 Machine jacking, 83–84
 Machine tie down location, 82
 Main broom, Stalled, Light, 21
 Main broom stalled light, 21
 Main brush, 36–37, 69–72
 Adjust brush taper, 72–74
 Bristle length, 69
 Checking brush pattern, 71–73
 Door latch, 28
 Door seals, 76
 Door skirts, 75
 Main brush adjustment knob, 19
 Maintenance, 69
 Replacing, 70–71
 Main brush adjustment knob, 19
 Maintenance, 54–75
 Intervals, 54–55
 Recommended, 7
 Maintenance chart, 54–55
 Motors, Propelling, 59

O

One Step switch, 14
Operating/hazard lights switch, 25
Operation, 7–55
Operation on inclines, 46
Operator Responsibility, 7
Options, 47–54
 Air conditioner, Circuit breakers, 27
 Air conditioning switch, 31
 Blower wand, 51–52
 Cab door latch, 28
 Dome light switch, 32
 Heater knob, 31
 Heater valve, 52
 Heavy duty air filter, 61
 Pressurizer switch, 32
 Side brush dust control skirts, 76
 Turn signal switch, 20
 Vacuum wand, 47–52
 Windshield wiper switch, 31

P

Parking brake, 79
 Adjustment, 79
Parking brake lever, 13
Pedals
 Brake, 13
 Directional, 12
Post-operation checklist, 42–43
Pre-operation checklist, 33–34
Pressurizer switch, 32
Priming fuel system, 63
Pushing machine, 80
Pushing or towing the machine, 80
Pushing, towing, and transporting machine, 80

R

Radiator, 60
 Coolant level, 7, 60
 Coolant type, 60
 Fins, 33, 42
 Flushing system, 60
 Hoses, 60
Rear wheel, 79

S

Safety
 Disengaging hopper support bar, 45–46
 Engaging hopper support bar, 43–44
 Hopper support bar, 29
 Labels, 5
 Precautions, 3
Seals, 75–78
 Brush doors, 76
 Hopper, 77
 Hopper door, 77
 Hopper inspection door, 78
 Hopper filter seals, 78
 Vacuum wand door, 78
Seat
 Deluxe suspension, 29
 Lift, 30
Service records, 42
Shake filter switch, 15
Side Brush, Dust skirts, 76
Side brush, 37, 73–74
 Bristle length, 73
 Checking brush pattern, 73
 Down pressure, 25
 Replacing, 74
Side brush down pressure knob, 25
Side brush dust control skirts, 76
Side brush guard, 74
Side brush switch, 15
Skirts, 75–76
 Brush doors, 75
 Hopper Lip, 75
 Hopper side, 75
 Rear, 76
 Side brush dust control, 76
Skirts and seals, 33, 42
Specifications, 84–86
 Braking system, 85
 Hydraulic system, 85
 Machine capacities, 84
 Machine dimensions, 84
 Machine performance, 84
 Power type, 85
 Steering, 85
 Tires, 84
Starting the machine, 34–35
Static drag chain, 64
Steering, 33, 42
 Specifications, 85

Steering column tilt lever, 23
Steering wheel, 23
Stop sweeping, 38
Stop the machine, 41–42
Storing machine, 83
Sweeping, 37–38
Sweeping and brush information, 36–37
Switches
 Air conditioning (option), 31
 Dome light, 32
 Engine speed control, 16
 Hopper close, 17
 Hopper down, 18
 Hopper open, 17
 Hopper up, 18
 Ignition, 24
 One Step, 14
 Operating/hazard lights, 25
 Pressurizer, 32
 Shake filter, 15
 Side brush, 15
 Turn signal, 20
 Vacuum fan, 15
 Windshield wiper, 31

T

Thermo Sentry Light, 22
Thermo-sentry, 68
Tie down location, 82
Tires, 79–80
 Pressure, 79
 Rear wheel, 79
 Specifications, 84
Towing machine, 80
Transporting machine, 80
Transporting the machine, 80
Travel speed, 84
Troubleshooting, 53
Turn signal switch, 20

V

Vacuum fan switch, 15
Vacuum wand, 47–52

W

Windshield wiper switch, 31

